

JVC

SERVICE MANUAL

AUDIO/VIDEO CONTROL RECEIVER

RX-6010VBK RX-6012VSL

Area Suffix	
RX-6010VBK	
UJ	----- U.S.military
RX-6012VSL	
UY	----- Argentina
US	----- Singapore
UP	----- Korea
A	----- Australia

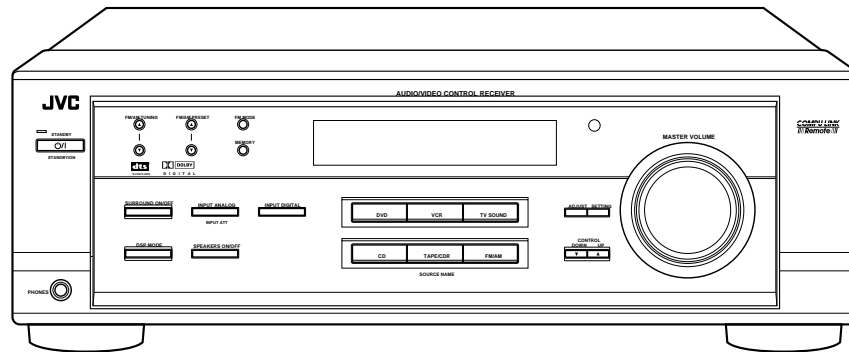
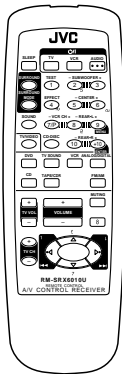

As for RX-6012VSL the body is silver color

Contents

Safety precautions	-----1-2
Disassembly method	-----1-3
Adjustment method	-----1-8
Description of major ICs	-----1-9~22

Safety Precautions

1. This design of this product contains special hardware and many circuits and components specially for safety purposes. For continued protection, no changes should be made to the original design unless authorized in writing by the manufacturer. Replacement parts must be identical to those used in the original circuits. Services should be performed by qualified personnel only.
2. Alterations of the design or circuitry of the product should not be made. Any design alterations of the product should not be made. Any design alterations or additions will void the manufacturer's warranty and will further relieve the manufacture of responsibility for personal injury or property damage resulting therefrom.
3. Many electrical and mechanical parts in the products have special safety-related characteristics. These characteristics are often not evident from visual inspection nor can the protection afforded by them necessarily be obtained by using replacement components rated for higher voltage, wattage, etc. Replacement parts which have these special safety characteristics are identified in the Parts List of Service Manual. Electrical components having such features are identified by shading on the schematics and by (\triangle) on the Parts List in the Service Manual. The use of a substitute replacement which does not have the same safety characteristics as the recommended replacement parts shown in the Parts List of Service Manual may create shock, fire, or other hazards.
4. The leads in the products are routed and dressed with ties, clamps, tubings, barriers and the like to be separated from live parts, high temperature parts, moving parts and/or sharp edges for the prevention of electric shock and fire hazard. When service is required, the original lead routing and dress should be observed, and it should be confirmed that they have been returned to normal, after re-assembling.

5. Leakage current check (Electrical shock hazard testing)

After re-assembling the product, always perform an isolation check on the exposed metal parts of the product (antenna terminals, knobs, metal cabinet, screw heads, headphone jack, control shafts, etc.) to be sure the product is safe to operate without danger of electrical shock.

Do not use a line isolation transformer during this check.

- Plug the AC line cord directly into the AC outlet. Using a "Leakage Current Tester", measure the leakage current from each exposed metal parts of the cabinet, particularly any exposed metal part having a return path to the chassis, to a known good earth ground. Any leakage current must not exceed 0.5mA AC (r.m.s.).

● Alternate check method

Plug the AC line cord directly into the AC outlet. Use an AC voltmeter having, 1,000 ohms per volt or more sensitivity in the following manner. Connect a 1,500 Ω 10W resistor paralleled by a 0.15 μ F AC-type capacitor between an exposed metal part and a known good earth ground. Measure the AC voltage across the resistor with the AC voltmeter.

Move the resistor connection to each exposed metal part, particularly any exposed metal part having a return path to the chassis, and measure the AC voltage across the resistor. Now, reverse the plug in the AC outlet and repeat each measurement. Voltage measured any must not exceed 0.75 V AC (r.m.s.). This corresponds to 0.5 mA AC (r.m.s.).

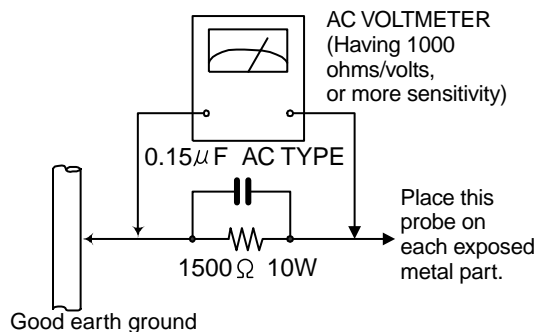

Warning

1. This equipment has been designed and manufactured to meet international safety standards.
2. It is the legal responsibility of the repairer to ensure that these safety standards are maintained.
3. Repairs must be made in accordance with the relevant safety standards.
4. It is essential that safety critical components are replaced by approved parts.
5. If mains voltage selector is provided, check setting for local voltage.

CAUTION

Burrs formed during molding may be left over on some parts of the chassis. Therefore, pay attention to such burrs in the case of preforming repair of this system.

In regard with component parts appearing on the silk-screen printed side (parts side) of the PWB diagrams, the parts that are printed over with black such as the resistor (■), diode (▣) and ICP (●) or identified by the " \triangle " mark nearby are critical for safety.

When replacing them, be sure to use the parts of the same type and rating as specified by the manufacturer. (Except the JC version)

Disassembly method

■ Removing the top cover (See Fig.1)

1. Remove the four screws A attaching the top cover on both sides of the body.
2. Remove the three screws B on the back of the body.
3. Remove the top cover from behind in the direction of the arrow while pulling both sides outward.

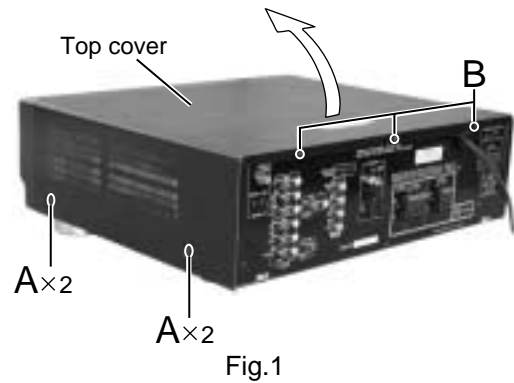

■ Removing the front panel assembly (See Fig.2 and 3)

- Prior to performing the following procedure, remove the top cover.
1. Disconnect the card wire from connector CN402 on the audio board and CN201 on the power supply board in the front panel assembly.
 2. Cut off the tie band fixing the harness.
 3. Remove the three screws C attaching the front panel assembly.
 4. Remove the four screws D attaching the front panel assembly on the bottom of the body. Detach the front panel assembly toward the front.

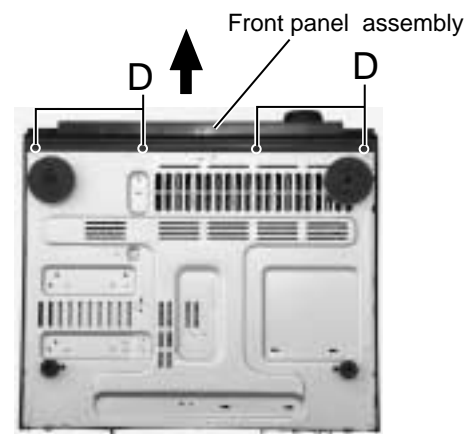
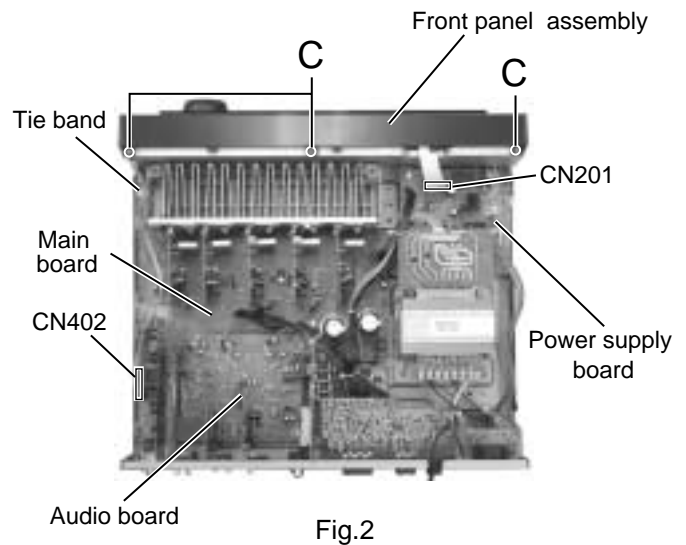

■ Removing the rear panel (See Fig.4)

- Prior to performing the following procedure, remove the top cover.
1. Remove the power cord stopper from the rear panel by moving it in the direction of the arrow.
 2. Remove the nineteen screws E attaching the each boards to the rear panel on the back of the body.
 3. Remove the four screws F attaching the rear panel on the back of the body.

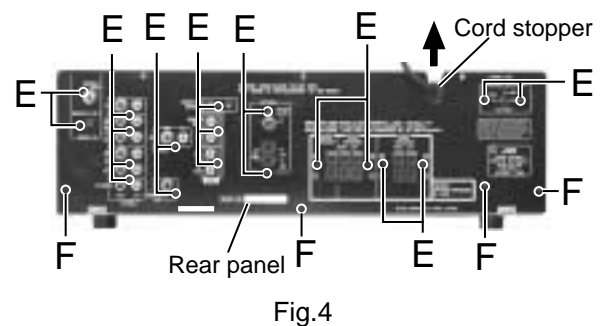

■ Removing each board connected to the rear side of the audio board

(See Fig.5 to 8)

• Prior to performing the following procedure, remove the top cover and the rear panel.

1. Cut off the tie band fixing the harness.
2. Disconnect the DSP board from connector CN481 on the audio board.
3. Disconnect the audio input board, DVD board and the video board from connector CN421, CN431 and CN441 on the audio board.
4. Disconnect the tuner board from connector CN411 on the audio board.

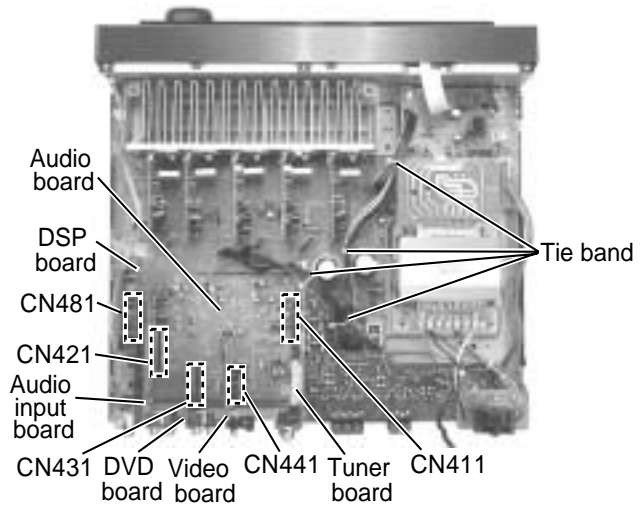

Fig.5

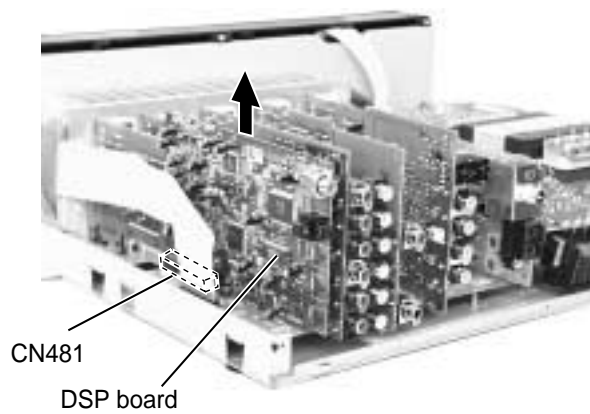

Fig.6

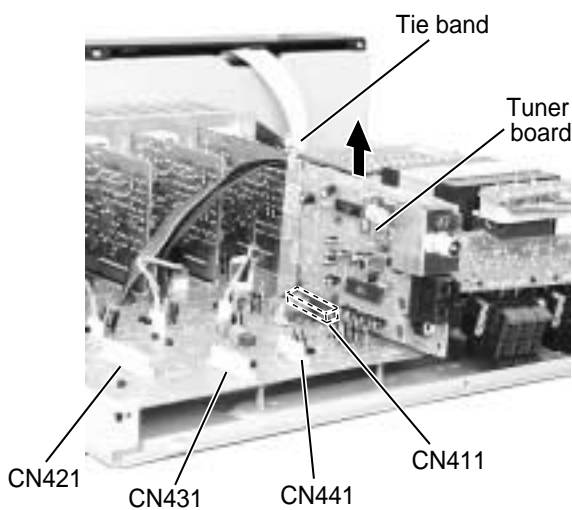

Fig.8

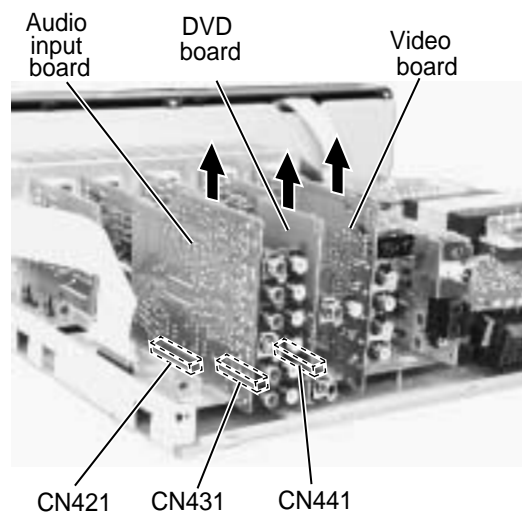

Fig.7

■ Removing the audio board (See Fig.9)

- Prior to performing the following procedure, remove the top cover and the rear panel.
1. Disconnect the card wire from connector CN402 on the audio board.
 2. Disconnect the relay board from the audio board and the power supply board. (CN291,CN491)
 3. Disconnect the harness from connector CN473, CN471, CN472, and CN385.
 4. Remove the three screws G attaching the audio board assembly.
 5. Remove the screw H attaching the audio board assembly.

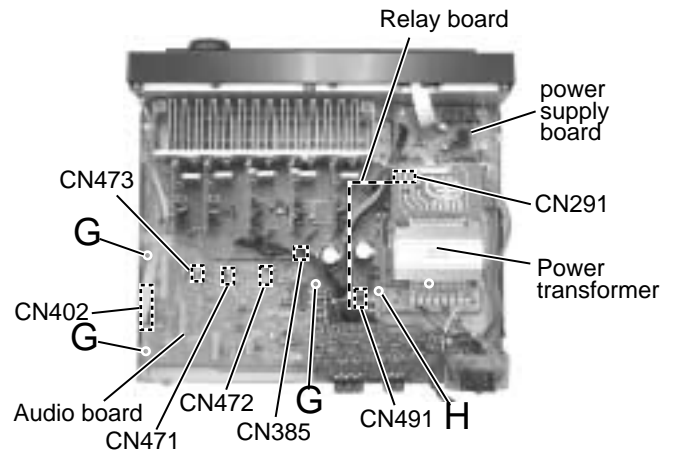

Fig.9

■ Removing the main board (See Fig.10)

- Prior to performing the following procedure, remove the top cover, the rear panel and audio board.
1. Disconnect the harness from connector CN241 and CN203 on the power supply board respectively.
 2. Remove the four screws I and the two screws J attaching the main board.

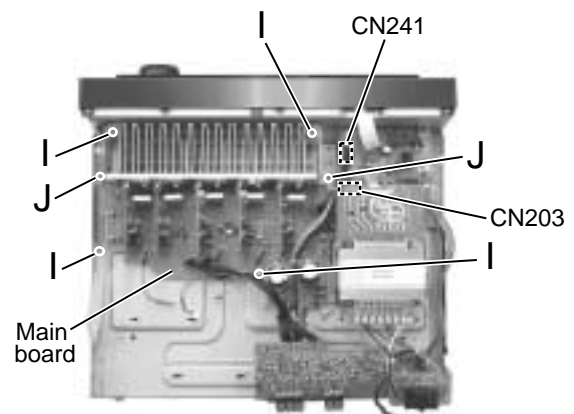

Fig.10

■ Removing the Heat sink (See Fig.11 and 12)

1. Remove the ten screws K and four screws L attaching the heat sink.
2. Remove the two screws L' attaching the heat sink from the rear side of main board.

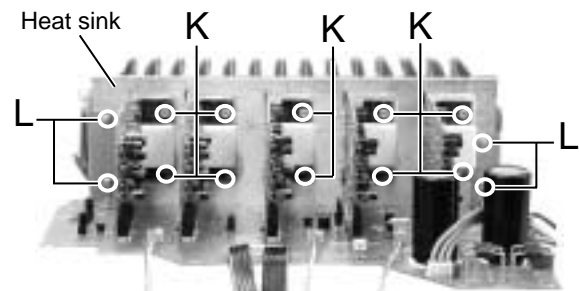

Fig.11

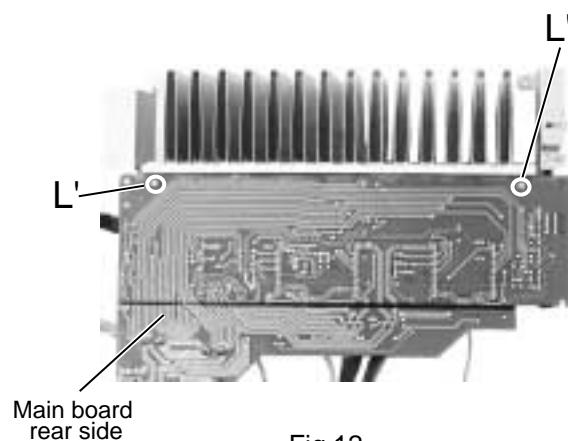

Fig.12

■ **Removing the power transformer**

(See Fig.13)

- Prior to performing the following procedures, remove the top cover.
1. Cut off the tie band fixing the harness.
 2. Unsolder the two harnesses connected to the power transformer.
 3. Disconnect the harness from connector CN251 and unsolder the harnesses connected to FW201 on the power transformer board.
 4. Remove the four screws M attaching the power transformer.

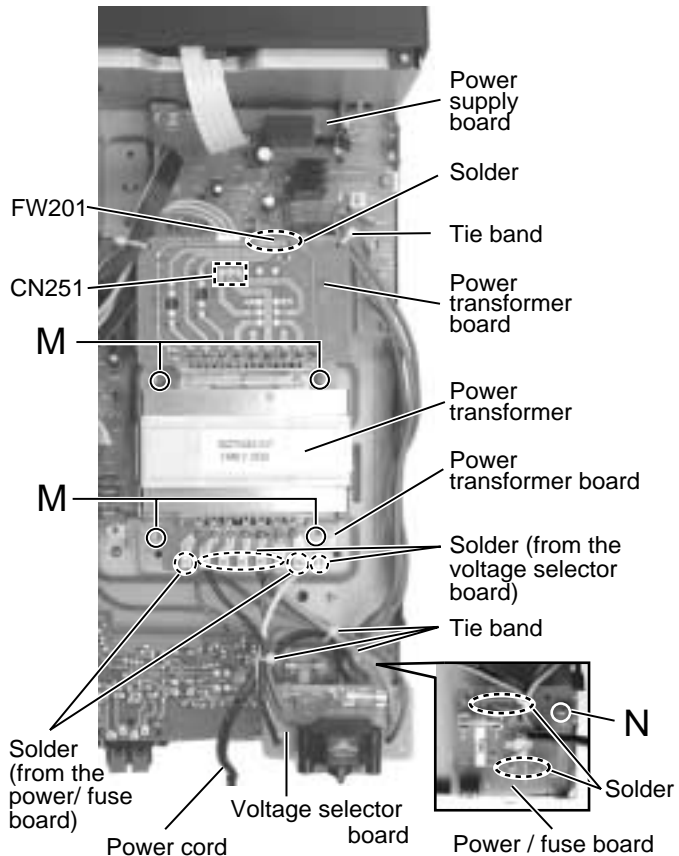

Fig.13

■ **Removing the voltage selector board and the power / fuse board**

(See Fig.13)

- Prior to performing the following procedure, remove the top cover and the rear panel.
1. Unsolder the six harnesses connected to the power transformer board and remove the voltage board.
 2. Remove the screw N attaching the power / fuse board.
 3. Unsolder the power cord and other harnesses connected to the power / fuse board.

■ **Removing the power supply board**

(See Fig.14 and 15)

- Prior to performing the following procedure, remove the top cover and the front panel.
1. Remove the one nut attaching the headphone jack of the power supply board on the front side of the body.
 2. Disconnect the harness connected to connector CN241, CN201, CN203 and CN291 on the power transformer board.
- Remove the three screws O attaching the power supply board and pull out the power supply board from the front bracket backward.
3. Unsolder the three harnesses connected to the power supply board.

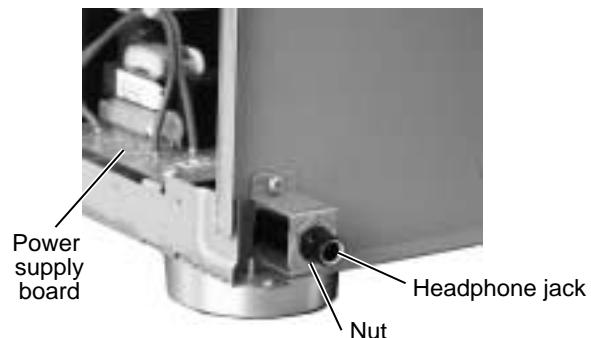

Fig.14

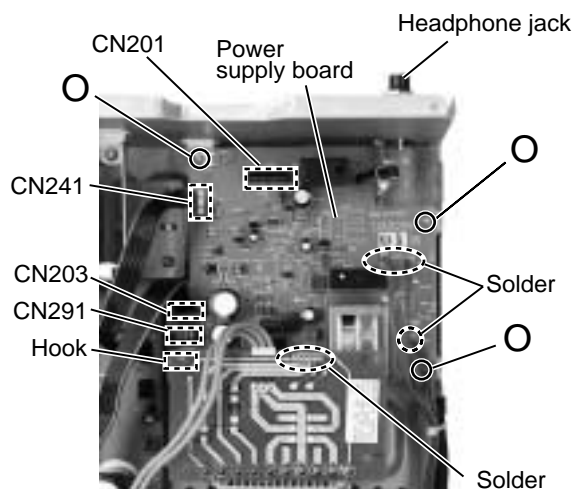

Fig.15

■ Removing the system control board / power switch board (See Fig.16 to 18)

• Prior to performing the following procedure, remove the top cover and the front panel assembly.

1. Pull out the volume knob on the front side of the front panel and remove the nut attaching the system control board.
2. Remove the two screws P attaching the power switch board.
3. Disconnect the harness from connector CN714 on the power switch board.
4. Remove the six screws Q attaching the system control board on the back of the front panel.
5. On the back of the front panel, release the eight joints by pushing the joint tabs inward. Remove the operation switch panel toward the front.
6. Release the two hook attaching the system control board.

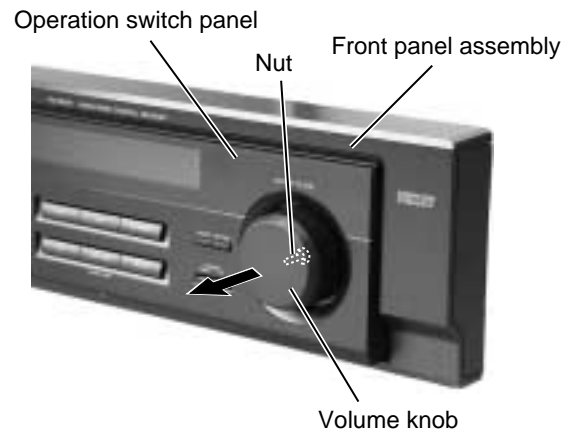

Fig.16

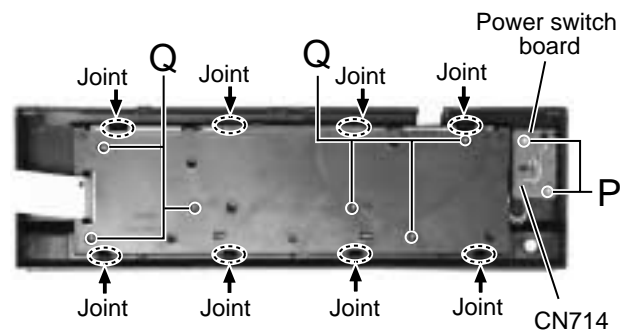

Fig.17

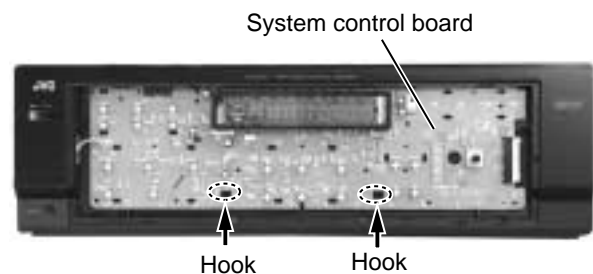

Fig.18

Adjustment method

■ Tuner section

1. Tuner range

FM	87.5MHz~108.0MHz
AM(MW)	531kHz~1710kHz

■ Power amplifier section

Adjustment of idling current

Measurement location	TP301(Lch) , TP302(Rch)
Adjustment part	VR301(Lch) , VR302(Rch)

Attention

This adjustment does not obtain a correct adjustment value immediately after the amplifier is used (state that an internal temperature has risen). Please adjust immediately after using the amplifier after turning off the power supply of the amplifier and falling an internal temperature.

<Adjustment method>

1. Set the volume control to minimum during this adjustment. (No signal & No load)
2. Set the surround mode OFF.
2. Turn VR301 and VR302 fully counterclockwise to warm up before adjustment.
If the heat sink is already warm from previous use the correct adjustment can not be made.
3. For L-ch, connect a DC voltmeter between TP301's B216 and B217 (Lch)
And, connect it between TP302's B218 and B219 (Rch).
4. 30 minutes later after power on, adjust VR301 for L-ch, or VR302 for R-ch so that the DC voltmeter value has 1mV~10mV.

* It is not abnormal though the idling current might not become 0mA even if it is finished to turn variable resistance (VR301, VR302) in the direction of counterclockwise.

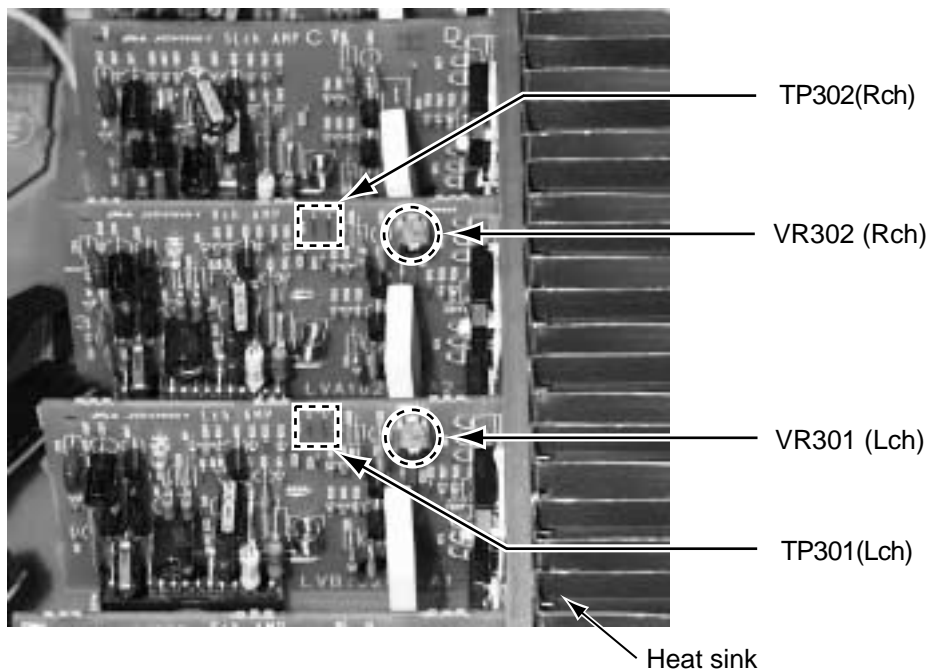

Description of major ICs

■ UPD784215AGC103 (IC671) : Unit CPU

1.Pin layout

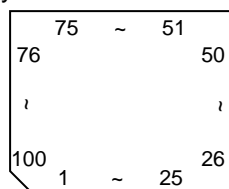

2.Pin function

Pin No.	Symbol	I/O	Function
1~8		-	Non connect
9	VDD	-	Power supply terminal
10	X2	O	Connecting the crystal oscillator for system main clock
11	X1	I	Connecting the crystal oscillator for system main clock
12	VSS	-	Connect to GND
13	XT2	O	Connecting the crystal oscillator for system sub clock
14	XT1	I	Connecting the crystal oscillator for system sub clock
15	RESET	I	System reset signal input
16	AUTODATA	I	Output of DSP to general-purpose port
17	LOCK	I	Output of DSP to general-purpose port
18	DIGITAL0	I	Output of DSP to general-purpose port
19	FORMAT	I	Output of DSP to general-purpose port
20	CHANNEL	I	Output of DSP to general-purpose port
21	ERR	I	Output of DSP to general-purpose port
22	RSTDET	I	Reset signal input
23	AVDD	-	Power supply terminal
24	AVREF0	-	Connect to GND
25~32		-	Connect to GND
33	AVSS	-	Connect to GND
34,35		-	Non connect
36	AV REF1	-	Power supply terminal
37,38	RX,TX	-	Not use
39		-	Non connect
40	DSPCOM	I	Communication port from IC701
41	DSPSTS	O	Status communication port to IC701
42	DSPCLK	I	Clock input from IC701
43	DSPRDY	I	Ready signal input from IC701
44		-	Non connect
45,46	MIDIO_IN/OUT	I/O	Interface I/O terminal with microcomputer
47	MICK	O	Interface I/O terminal with microcomputer of clock signal
48	MICS	O	Interface I/O terminal with microcomputer of chip select
49	MILP	O	Interface I/O terminal with microcomputer
50	MIACK	O	Interface I/O terminal with microcomputer
51,52		-	Non connect
53	DSPRST	O	Reset signal output of DSP
54~63		-	Non connect
64,65	CDTI/CDTO	I/O	Interface I/O terminal with microcomputer
66	CCLK	O	Interface I/O terminal with microcomputer of clock signal
67	CS	O	Interface I/O terminal with microcomputer of chip select
68	XTS	O	OSC Select
69,70		-	Non connect
71	PD	O	Reset signal output
72	GND	-	Connect to GND
73~80		-	Non connect
81	VDD	-	Power supply
82	3D-ON	-	Non connect
83	3D-ON	O	Switch at output destination of surround channel
84	ANA/T-TONE	O	Test tone control
85	REF-MIX	O	Control at output destination of LFE channel
86		-	Non connect
87	D.MUTE	O	Mute of the digital out terminal is controlled
88	S.MUTE	O	Mute of the audio signal is controlled
89		-	Non connect
90~93	ASW1~4	O	Selection of digital input selector
94	TEST	-	Test terminal
95~100		-	Non connect

■ AK4527BVQ (IC601) : A/D,D/A Converter

1.Pin layout

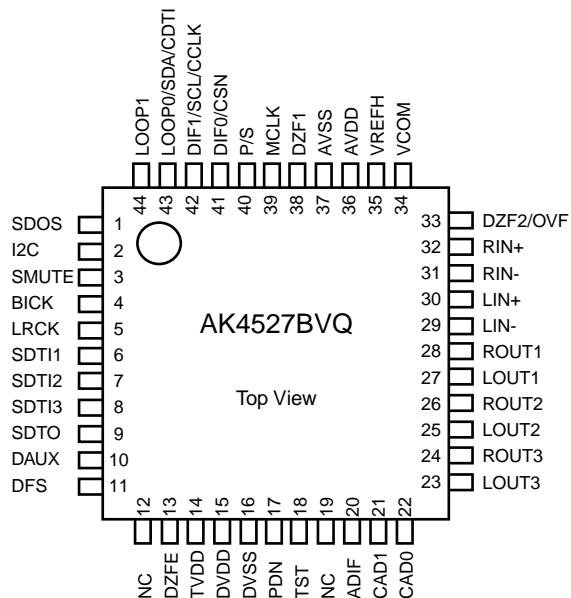

2. Pin function (1/2)

AK4527(1/2)

No.	Pin name	I/O	Function
1	SDOS	I	SDTO Source Select Pin (Note 1) "L" : Internal ADC output, "H" : DAUX input
2	I2C	I	Control Mode Select Pin "L" : 3-wire Serial, "H" : I2C Bus
3	SMUTE	I	Soft Mute Pin (Note 1) When this pin goes to "H", soft mute cycle is initialized. When returning to "L", the output mute releases.
4	BICK	I	Audio Serial Data Clock Pin
5	LRCK	I/O	Input Channel Clock Pin
6	SDTI1	I	DAC1 Audio Serial Data Input Pin
7	SDTI2	I	DAC2 Audio Serial Data Input Pin
8	SDTI3	I	DAC3 Audio Serial Data Input Pin
9	SDTO	O	Audio Serial Data Output Pin
10	DAUX	I	Sub Audio Serial Data Input Pin
11	DFS	I	Double Speed Sampling Mode Pin (Note 1) "L" : Normal Speed, "H" : Double Speed
12	NC	-	No Connect No internal bonding.
13	DZEF	I	Zero Input Detect Enable Pin "L" : mode 7 (disable) at parallel mode, zero detect mode is selectable by DZFM2-0 bits at serial mode. "H" : mode 0 (DZF is AND of all six channels)
14	TVDD	-	Output Buffer Power supply Pin, 2.7V~5.5V
15	DVDD	-	Digital Power Supply Pin, 4.5V~5.5V
16	DVSS	-	De-emphasis Pin, 0V
17	PDN	I	Power-Down & Reset Pin When "L", the AK4527B is powered-down and the control registers are reset to default state. If the state of P/S or CAD0-1 changes, then the AK4527B must be reset by PDN.
18	TST	I	Test Pin This pin should be connected to DVSS.

Pin function (2/2)

AK4527(1/2)

No.	Pin name	I/O	No Connect	Function
19	NC	-	No internal bonding.	Analog Input Format Select Pin
20	ADIF	I	"H" : Full-differential input, "L" : Single-ended input	Chip Address 1 Pin
21	CAD1	I		Chip Address 0 Pin
22	CAD0	I		DAC3 Lch Analog Output Pin
23	LOUT3	O		DAC3 Rch Analog Output Pin
24	ROUT3	O		DAC2 Lch Analog Output Pin
25	LOUT2	O		DAC2 Rch Analog Output Pin
26	ROUT2	O		DAC1 Lch Analog Output Pin
27	LOUT1	O		DAC1 Rch Analog Output Pin
28	ROUT1	O		Lch Analog Negative Input Pin
29	LIN-	I		Lch Analog Positive Input Pin
30	LIN+	I		Rch Analog Negative Input Pin
31	RIN-	I		Rch Analog Positive Input Pin
32	RIN+	I		Zero Input Detect 2 Pin (Note 2)
33	DZF2	O	When the input data of the group 1 follow total 8192LRCK cycles with "0" input data, this pin goes to "H".	Analog Input Overflow Detect Pin (Note 3)
	OVF	O	This pin goes to "H" if the analog input of Lch or Rch is overflows.	Common Voltage Output Pin,AVDD/2
34	VCOM	O	Large external capacitor around 2.2uF is used to reduce power-supply noise.	Positive Voltage Reference Input Pin,AVDD
35	VREFH	I		Analog Power Supply Pin,4.5V~5.5V
36	AVDD	-		Analog Ground Pin,0V
37	AVSS	-		Zero Input Detect 1 Pin (Note 2)
38	DZF1	O	When the input data of the group 1 follow total 8192 LRCK cycles with "0" input data, this pin goes to "H".	Master Clock Input Pin
39	MCLK	I		Parallel / Serial Select Pin
40	P/S	I	"L" : Serial control mode, "H" : Parallel control mode	Audio Data Interface Format 0 Pin in parallel mode
41	DIF0	I		Chip select pin in 3-wire serial control mode
	CSN	I		This pin should be connected to DVDD at I2C bus control mode Audio Data Interface Format 1 Pin in parallel mode
42	DIF1	I		Control Data Clock Pin in serial control mode
	SCL/CCLK	I	I2C = "L" : CCLK(3-wire Serial), I2C = "H" : SCL(I2C Bus)	Loopback Mode 0 Pin in parallel control mode
43	LOOP0	I	Enables digital loop-back from ADC to 3 DACs.	Control Data Input Pin in serial control mode
	SAD/CDTI	I/O	I2C = "L" : CDTI(3-wire Serial), I2C = "H" : SDA(I2C Bus)	Loopback Mode 1 Pin (Note 1)
44	LOOP1	I		Enable all 3 DAC channels to be input from SDTII.

- Notes : 1. SDOS, SMUTE, DFS, and LOOP1 pins are ORed with register data if P/S = "L".
2. The group 1 and 2 can be selected by DZFM2-0 bit if P/S = "L" and DZFM2 = "L".
3. This pin becomes OVF pin if OVFE bit is set to "1" at serial control mode.
4. All input pins should not be left floating.

■ M62446FD(IC428) : 6CH Master volume

1. Block Diagram

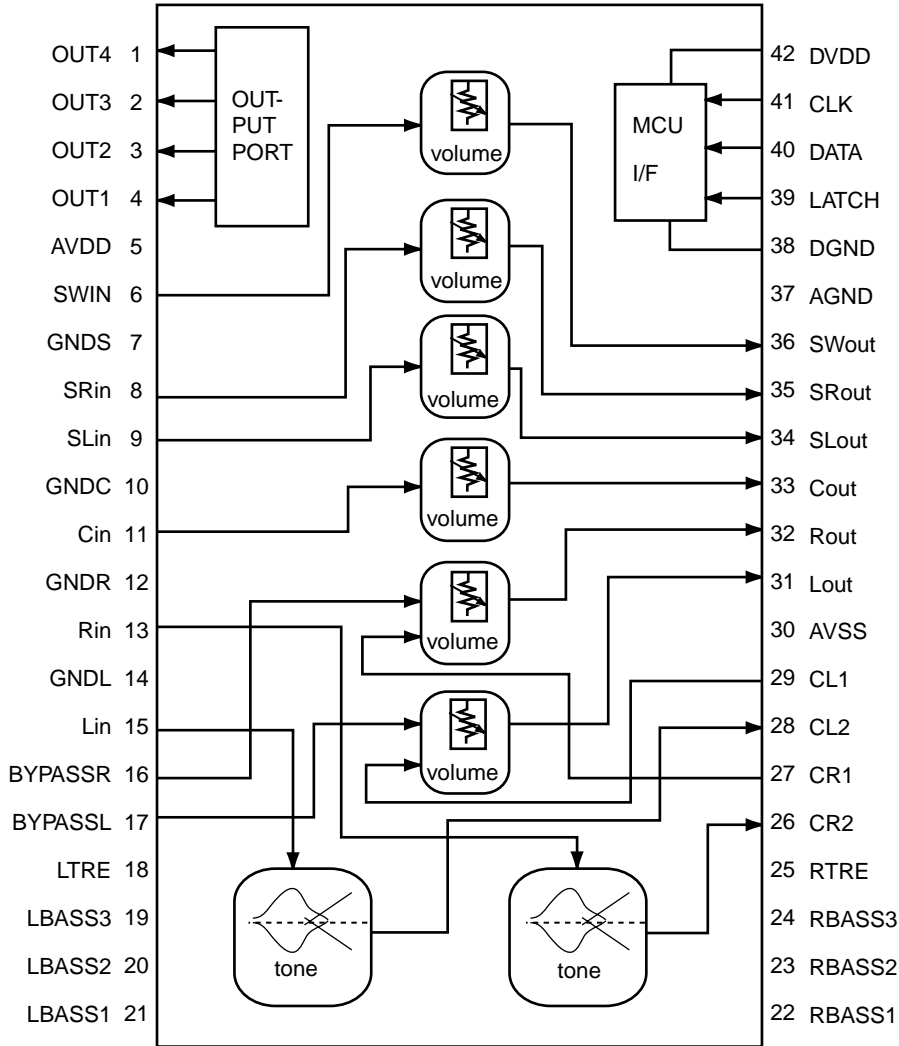

2.Pin Function

Pin No.	Symbol	I/O	Descriptions
1	SURROUND	O	SURROUND control terminal
2	BASS BOOST	O	BASS BOOST control terminal
3	INPUT-ATT	O	Input attenuator control terminal
4	MUTING	O	MUTING control terminal
5	AVDD	-	Analog positive power supply terminal
6	SWIN	I	SUB Woofer volume signal input terminal
7	A.GND	-	Analog ground terminal
8	RR IN	I	R ch volume signal input terminal for rear speaker
9	RL IN	I	L ch volume signal input terminal for rear speaker
10	A.GND	-	Analog ground terminal
11	C IN	I	Center volume signal input terminal
12	A.GND	-	Analog ground terminal
13	R IN	I	R ch volume signal input terminal
14	A.GND	-	Analog ground terminal
15	L IN	I	L ch volume signal input terminal
16,17	BYPASSR,L	-	Non connect
18	LTRE	-	Frequency adjustment terminal tone/treble
19~21	LBASS3~1	-	Frequency adjustment terminal tone/bass
22	CR2	O	Tone output terminal
23,24	RBASS2,4	-	Frequency adjustment terminal tone/bass
25	RTRE	-	Frequency adjustment terminal tone/treble
26	RBASS1	-	Frequency adjustment terminal tone/bass
27	CR1	I	L/R volume input terminal
28	CL2	O	Tone output terminal
29	CL1	I	L/R volume input terminal
30	AVSS	-	Analog negative power supply terminal
31	L OUT	O	L ch output
32	R OUT	O	R ch output
33	C OUT	O	Center volume signal output terminal
34	RL OUT	O	L ch volume signal output terminal for rear speaker
35	RR OUT	O	R ch volume signal output terminal for rear speaker
36	SW OUT	O	SUB Woofer volume signal output terminal
37	A.GND	-	Analog ground terminal
38	D.GND	-	Digital ground terminal
39	VOL STB	I	Latch input terminal
40	VOL DATA	I	Volume data input terminal
41	VOL CLK	I	Clock input terminal for data transfer
42	DVDD	-	Digital power supply terminal

■MN101C35DHK1 (IC701) : System controller

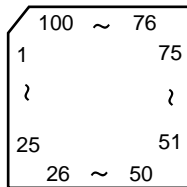

Pin function (1/2)

Pin No.	Symbol	I/O	Function
1	TXD/SB00/P00	I	VOL.JOG IN_1
2	RXD/SBI0/P01	I	VOL.JOG IN_2
3	SBT0/P02	I/O	DATA (PLL)
4	SB01/P03	O	CLK (PLL)
5	SBI1/P04	O	DE (PLL)
6	SBT1/P05	I	VIDEO S/C DVD
7	BUZZER/P06	I	VIDEO S/C VCR
8	VDD	-	Power supply +5V
9,10	OSC1,2	I/O	OSC (8MHz)
11	VSS	-	GND
12	XI	I	GND
13	X0	O	OPEN
14	MMOD	I	GND
15	VREF-	-	GND
16	AN0/PA0	I	KEY INPUT 1 (7KEY)
17	AN1/PA1	I	KEY INPUT 2 (7KEY)
18	AN2/PA2	I	KEY INPUT 3 (7KEY)
19	AN3/PA3	I	KEY INPUT 4 (7KEY)
20	AN4/PA4	I	KEY INPUT 5 (7KEY)
21	AN5/PA5	I	INH IN
22	AN5/PA5	I	CHIP SELECT 1
23	AN5/PA5	I	CHIP SELECT 2
24	VREF+	-	Power supply +5V
25	P07	I	VIDEO S/C DBS
26	RST /P27	I	RESET INPUT
27	RNOUT/TM0I0/P10	O	RDS CLK OUT (RDS)
28	TM1I0/P11	I	DCS INPUT
29	TM2I0/P12	O	DCS OUTPUT
30	TM3I0/P13	I	AVLINK VCR IN
31	TM4I0/P14	O	AVLINK VCR OUT
32	P15	I/O	RDS DATA (RDS)
33	IRQ0/P20	I	PROTECTOR IN
34	SENS/IRQ1/P21	I	REMOCON INPUT
35	IRQ2/P22	I	TUNED IN (TUNER)
36	IRQ3/P23	I	STEREO IN (TUNER)
37	IRQ4/P24	I	RDS DAVN (RDS)
38	P25	I	SELF CHECK INPUT
39	SB02/P30	O	COMMAND (DSP)
40	SBI2/P31	I	STATUS (DSP)

Pin function (2/2)

Pin No.	Symbol	I/O	Function
41	SBT2/P32	O	CLK (DSP)
42	P50	O	READY (DSP)
43	P51	O	RESET (DSP)
44	P52	O	RELAY S
45	P53	O	RELAY C
46	P54	O	RELAY L/R 1
47	DGT17/P67	O	RELAY L/R 2
48	DGT16/P66	O	RELAY HEADPHONE
49~64	G16~G1	O	FL GRID SIGNAL CONTROL OUT
65~80	P87~P90	O	FL SEGMENT SIGNAL CONTROL OUT
81	SEG24/PC2	O	LED8 SIGNAL CONTROL OUT (FM/AM)
82	SEG25/PC1	O	LED7 SIGNAL CONTROL OUT (TV/DBS)
83	SEG26/PC0	O	LED6 SIGNAL CONTROL OUT (TAPE/CDR)
84	SEG27/PB7	O	LED5 SIGNAL CONTROL OUT (VCR)
85	SEG28/PB6	O	LED4 SIGNAL CONTROL OUT (CD)
86	SEG29/PB5	O	LED3 SIGNAL CONTROL OUT (DVD)
87	SEG30/PB4	O	LED2 SIGNAL CONTROL OUT (PHONO)
88	SEG31/PB3	O	LED1 SIGNAL CONTROL OUT (DVD MULTI)
89	SEG32/PB2	O	SOUSE MUTE
90	SEG33/PB1	O	SUBWOOFER MUTE
91	SEG34/PB0	O	TUNER MUTE
92	SEG35/PD7	O	POWER ON (STANDBY)
93	SEG36/PD6	O	SURROUND
94	SEG37/PD5	O	DATA (A.SW)
95	SEG38/PD4	O	CLK (A.SW)
96	SEG39/PD3	O	STB (A.SW)
97	SEG40/PD2	O	LATCH (A.SW)
98	SEG41/PD1	O	DATA (VOL)
99	SEG42/PD0	O	CLK (VOL)
100	VPP	O	VPP

■ LA1838 (IC102) : FM AM IF amp & detector, FM MPX decoder

1. Block Diagram

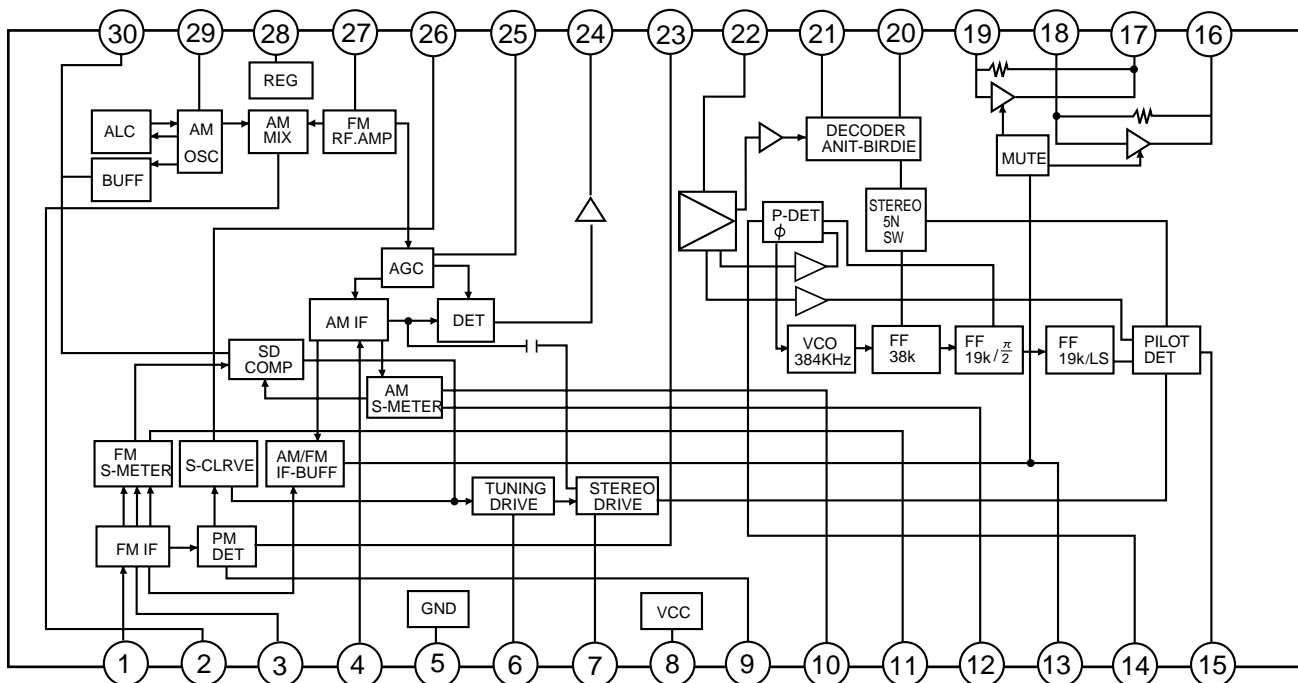

2. Pin Function

Pin No.	Symbol	I/O	Function	Pin No.	Symbol	I/O	Function
1	FM IN	I	This is an input terminal of FM IF signal.	16	L OUT	O	Left channel signal output.
2	AM MIX	O	This is an out put terminal for AM mixer.	17	R OUT	O	Right channel signal output.
3	FM IF	I	Bypass of FM IF	18	L IN	I	Input terminal of the left channel post AMP.
4	AM IF	I	Input of AM IF Signal.	19	R IN	I	Input terminal of the right channel post AMP.
5	GND	—	This is the device ground terminal.	20	RO	O	Mpx Right channel signal output.
6	TUNED	O	When the set is tuning, this terminal becomes "L".	21	LO	O	Mpx Left channel signal output.
7	STEREO	O	Stereo indicator output. Stereo "L", Mono: "H"	22	IF IN	I	Mpx input terminal
8	VCC	—	This is the power supply terminal.	23	FM OUT	O	FM detection output.
9	FM DET	—	FM detect transformer.	24	AM DET	O	AM detection output.
10	AM SD	—	This is a terminal of AM ceramic filter.	25	AM AGC	I	This is an AGC voltage input terminal for AM
11	FM VSM	O	Adjust FM SD sensitivity.	26	AFC	—	This is an output terminal of voltage for FM-AFC.
12	AM VSM	O	Adjust AM SD sensitivity.	27	AM RF	I	AM RF signal input.
13	MUTE	I/O	When the signal of IF REQ of IC121(LC72131) appear, the signal of FM/AM IF output. //Muting control input.	28	REG	O	Register value between pin 26 and pin28 desides the frequency width of the input signal.
14	FM/AM	I	Change over the FM/AM input. "H" :FM, "L" : AM	29	AM OSC	—	This is a terminal of AM Local oscillation circuit.
15	MONO/ST	O	Stereo : "H", Mono: "L"	30	OSC BUFFER	O	AM Local oscillation Signal output.

■ LC72136N (IC121) : PLL frequency synthesizer

1. Pin layout

XT	1	22	XT
FM/AM	2	21	GND
CE	3	20	LPFOUT
DI	4	19	LPFIN
CLOCK	5	18	PD
DO	6	17	VCC
FM/ST/VCO	7	16	FMIN
AM/FM	8	15	AMIN
	9	14	
	10	13	IFCONT
SDIN	11	12	IFIN

2. Block diagram

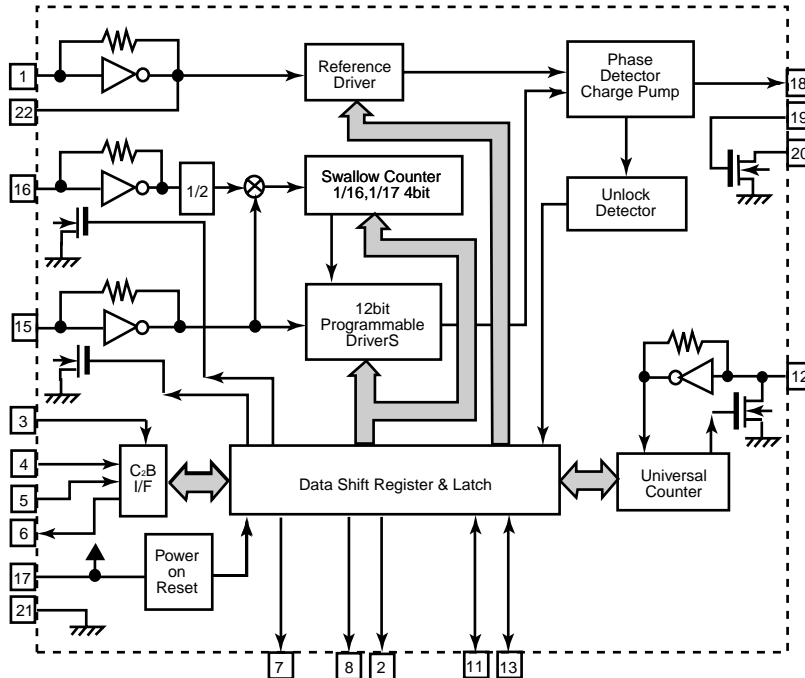

3. Pin function

Pin No.	Symbol	I/O	Function	Pin No.	Symbol	I/O	Function
1	XT	I	X'tal oscillator connect (75kHz)	12	IFIN	I	IF counter signal input
2	FM/AM	O	LOW:FM mode	13	IFCONT	O	IF signal output
3	CE	I	When data output/input for 4pin(input) and 6pin(output): H	14	-	-	Not use
4	DI	I	Input for receive the serial data from controller	15	AMIN	I	AM Local OSC signal output
5	CLOCK	I	Sync signal input use	16	FMIN	I	FM Local OSC signal input
6	DO	O	Data output for Controller Output port	17	VCC	-	Power suply(VDD=4.5-5.5V) When power ON:Reset circuit move
7	FM/ST/VCO	O	"Low": MW mode	18	PD	O	PLL charge pump output(H: Local OSC frequency Height than Reference frequency. L: Low Agreement: Height impedance)
8	AM/FM	O	Open state after the power on reset	19	LPFIN	I	Input for active lowpassfilter of PLL
9	LW	I/O	Input/output port	20	LPFOUT	O	Output for active lowpassfilter of PLL
10	MW	I/O	Input/output port	21	GND	-	Connected to GND
11	SDIN	I/O	Data input/output	22	XT	I	X'tal oscillator(75KHz)

■ TC9162AF (IC423) : Analog switch

VSS	1	28	VDD
L-S1	2	27	R-S1
L-S2	3	26	R-S2
L-COM1	4	25	R-COM1
L-S3	5	24	R-S3
L-S4	6	23	R-S4
L-COM2	7	22	R-COM2
L-S5	8	21	R-S5
L-S6	9	20	R-S6
L-COM3	10	19	R-COM3
L-S7	11	18	R-S7
L-COM4	12	17	R-COM4
ST	13	16	DATA
GND	14	15	CK

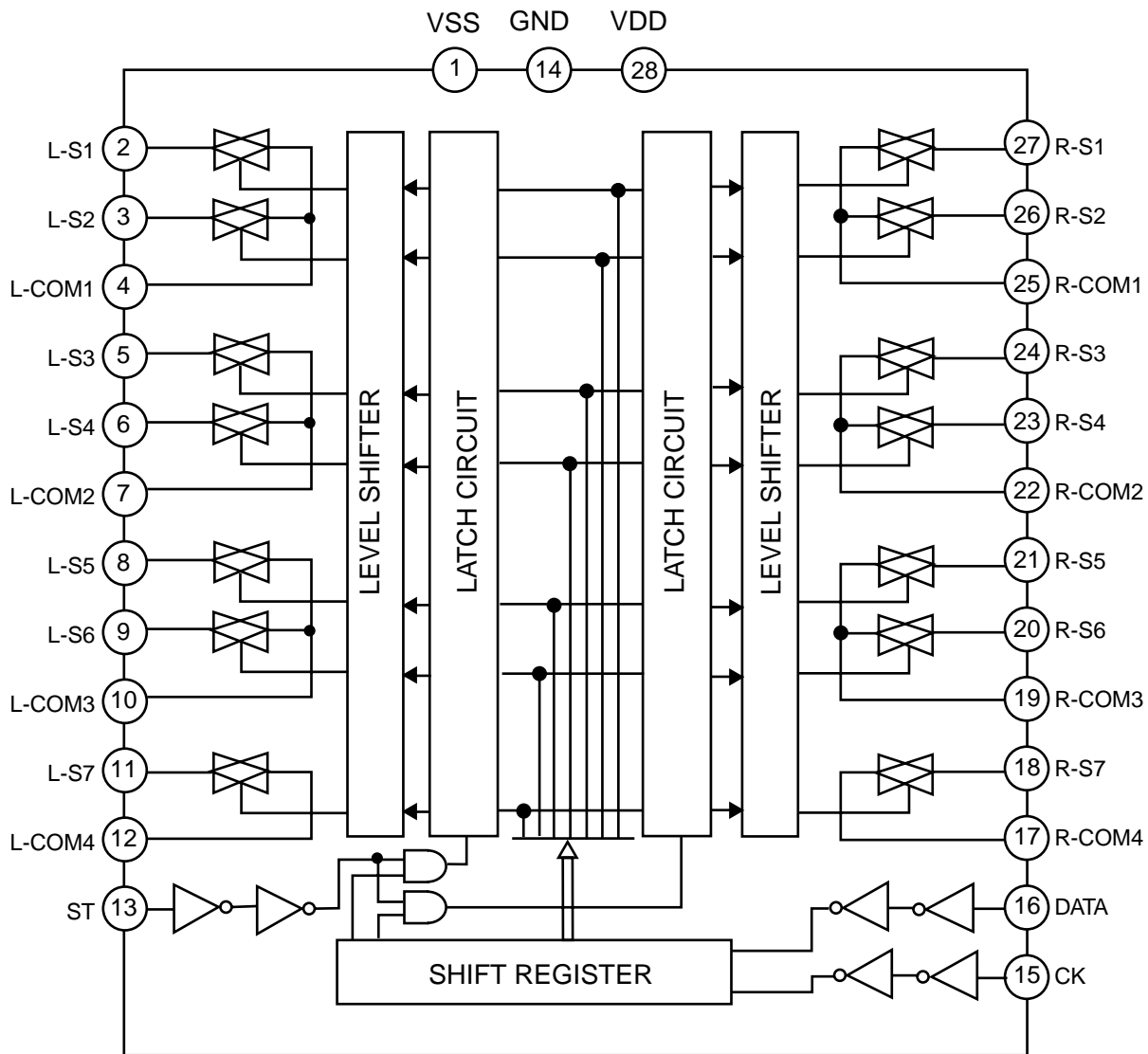

**■ TC9446F-014 (IC631) : Digital signal processor for dolby digital (AC-3)
/ MPEG2 audio decode**

Pin No.	Symbol	I/O	Function
1	RST	I	Reset signal input terminal (L:reset H:Operation usually)
2	MIMD	I	Microcomputer interface mode selection input terminal (L:serial H:IC bus)
3	MICS	I	Microcomputer interface chip select input terminal
4	MILP	I	Microcomputer interface latch pulse input
5	MIDIO	I/O	Microcomputer interface data I/O terminal
6	MICK	I	Microcomputer interface clock input terminal
7	MIACK	O	Microcomputer interface acknowledge output terminal
8~11	FI0~3	I	Flag input terminal 0~3
12	IRQ	I	Interrupt input terminal
13	VSS	-	Digital ground terminal
14	LRCKA	I	Audio interface LR clock input terminal A
15	BCKA	I	Audio interface bit clock input terminal A
16~18	SDO0~2	O	Audio interface data output terminal 0
19	SD03	-	Non connect
20	LRCKB	I	Audio interface LR clock input terminal B
21	BCKB	I	Audio interface bit clock input terminal B
22	SDT0	I	Audio interface data input terminal 0
23	SDT1	I	Audio interface data input terminal 1
24	VDD	-	Power supply for digital circuit
25	LRCKOA	O	Audio interface LR clock output terminal A
26	BCKOA	O	Audio interface bit clock output terminal A
27,28	TEST0,1	I	Test input terminal 0/1 (L:test H:operation usually)
29~31	LRCKOB,BCKOB,TXO	-	Non connect
32,33	TEST2,3	I	Test input terminal (L:test H:operation usually)
34	RX	I	SPDIF input terminal
35	VSS	-	Ground terminal for digital circuit
36	TSTSUB0	I	Test sub input terminal 0 (L:test H:operation usually)
37	FCONT	O	VCO Frequency control output terminal
38,39	TSTSUB1,TSTSUB2	I	Test sub input terminal 1,2 (L:test H:operation usually)
40	PDO	O	Phase error signal output terminal
41	VDDA	-	Power supply for analog circuit
42	PLON	I	Clock selection input terminal (L:external clock H:VCO clock)
43	AMPI	I	AMP.input terminal for LPF
44	AMPO	O	AMP.output terminal for LPF
45	CKI	I	External clock input terminal
46	VSSA	-	Ground terminal for analog circuit
47	CKO	O	DIR Clock output terminal
48	LOCK	O	VCO Lock detection output terminal
49	VSS	-	Ground terminal for digital circuit
50	WR	O	External SRAM writing signal output terminal
51	OE	O	External SRAM output enable signal output terminal
52	CE	O	External SRAM chip enable signal output terminal
53	VDD	-	Power supply terminal for digital circuit
54~61	IO7~0	I/O	External SRAM data I/O terminal 7~0
62	VSS	-	Ground terminal for digital circuit
63~70	AD0~7	O	External SRAM address output terminal 0~7
71	VDD	-	Power supply terminal for digital circuit
72~80	AD8~16	O	External SRAM address output terminal 8~16
81	VSS	-	Ground terminal for digital circuit
82~89	PO0~7	O	General purpose output terminal 0~7
90	VDDL	-	Power supply terminal for DLL
91	LPFO	O	LPF output terminal for DLL
92,93	DLON,DLCKS	I	Refer to the undermentioned table
94	SCKO	-	Non connect
95	VSSDL	-	Ground terminal for DLL
96	SCKI	I	External system clock input terminal
97	VSSX	-	Ground terminal for oscillation circuit
98,99	XO,XI	I/O	Oscillation I/O terminal
100	VDDX	-	Power supply terminal for oscillation circuit

DLCKS terminal	DLONterminal	DLL clock setting
L	L	SCKI input (DLL circuit OFF)
L	H	Four times XI clock
H	L	Three times XI clock
H	H	Six times XI clock

■ **AS7C31025-15 (IC641) : CMOS SRAM**

1. Pin layout

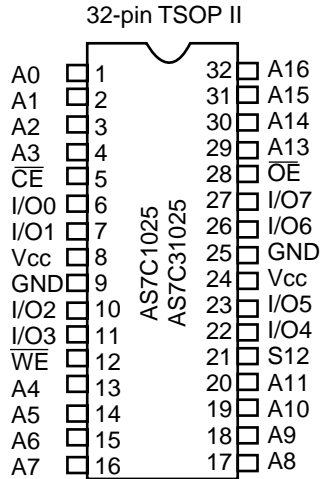

2. Block diagram

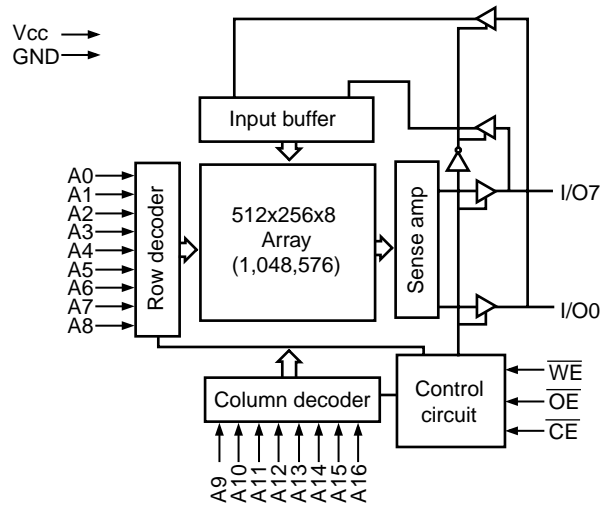

■ **BA15218F (IC427, 609, 610, 650, 651, 661, 690, 691) : Op amp.**

■ **BA15218N (IC403) : Dual op. amp.**

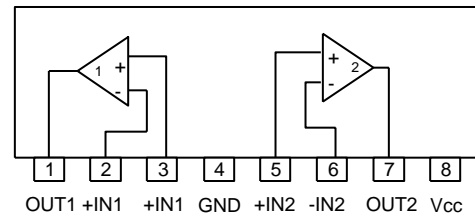
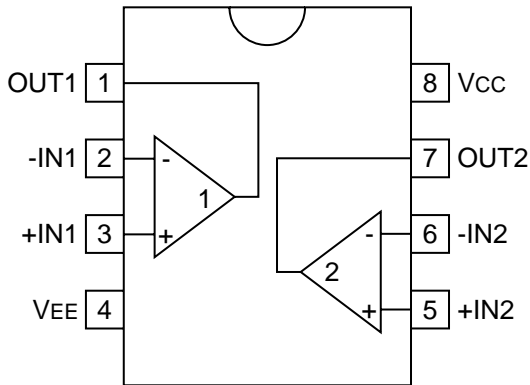

■ **BU4066BCF (IC611) : Switch**

1. Terminal Layout

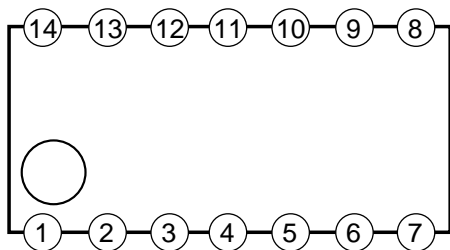

2. Block Diagram

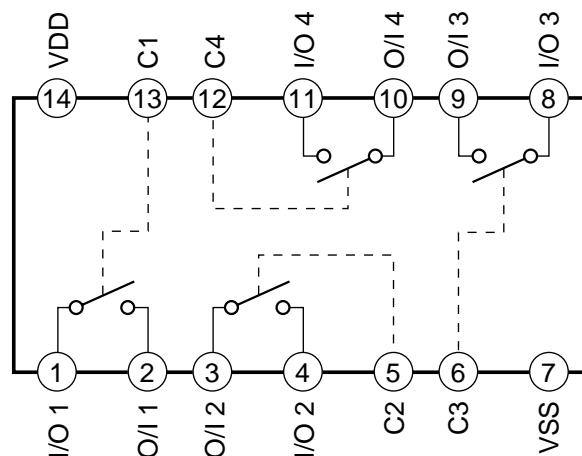

■ NJM2246D (IC501) : Video switch

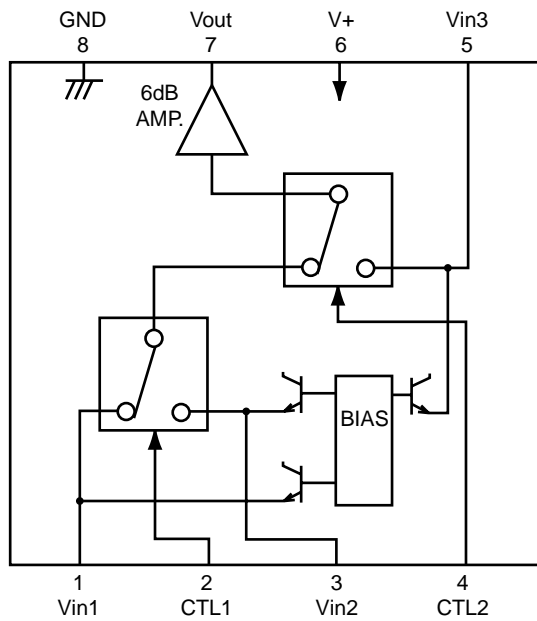

Control input - output signal

CTL 1	CTL 2	Output
L	L	VIN 1
H	L	VIN 2
L/H	H	VIN 3

■ PQ3DZ53 (IC681) : Regulator IC

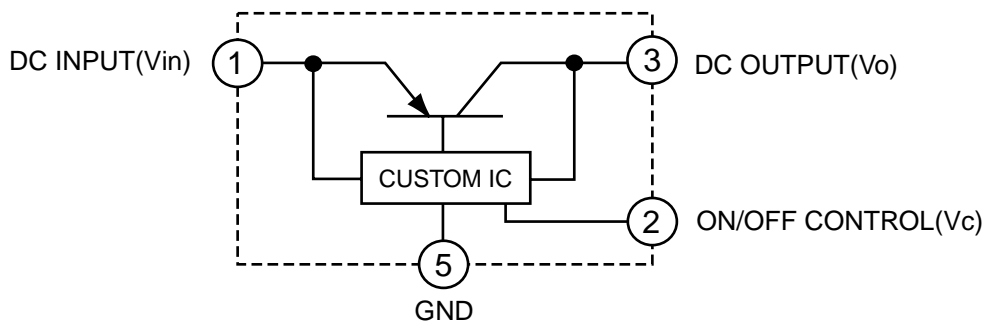

■ RN5RZ33BA (IC683) : Voltage regulator

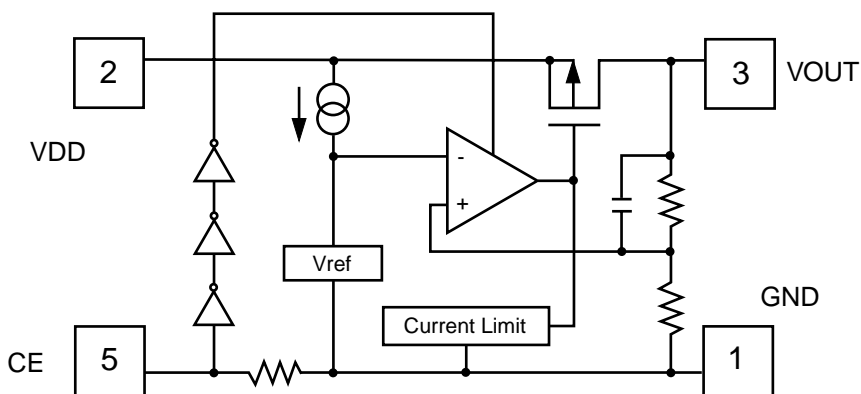

■ **TC7SET32FU (IC672) : Z-Input or gate**

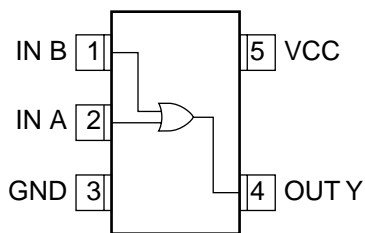
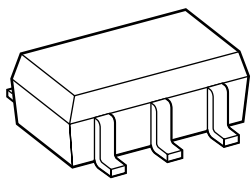

■ **TC7SU04FU (IC621, 622) : High speed CMOS inverter**

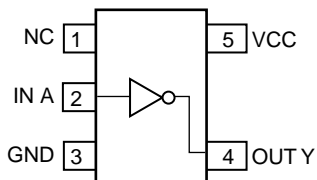

■ **TC9164AN (IC402) : Analog switch**

1. Function

Switch to On/Off of S1 to S8 by control of LSI.

2. Terminal Lay out & Block Diagram

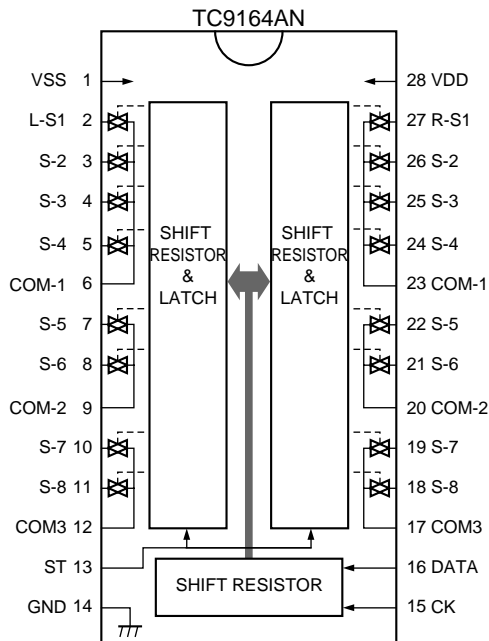

< MEMO >

Block diagram

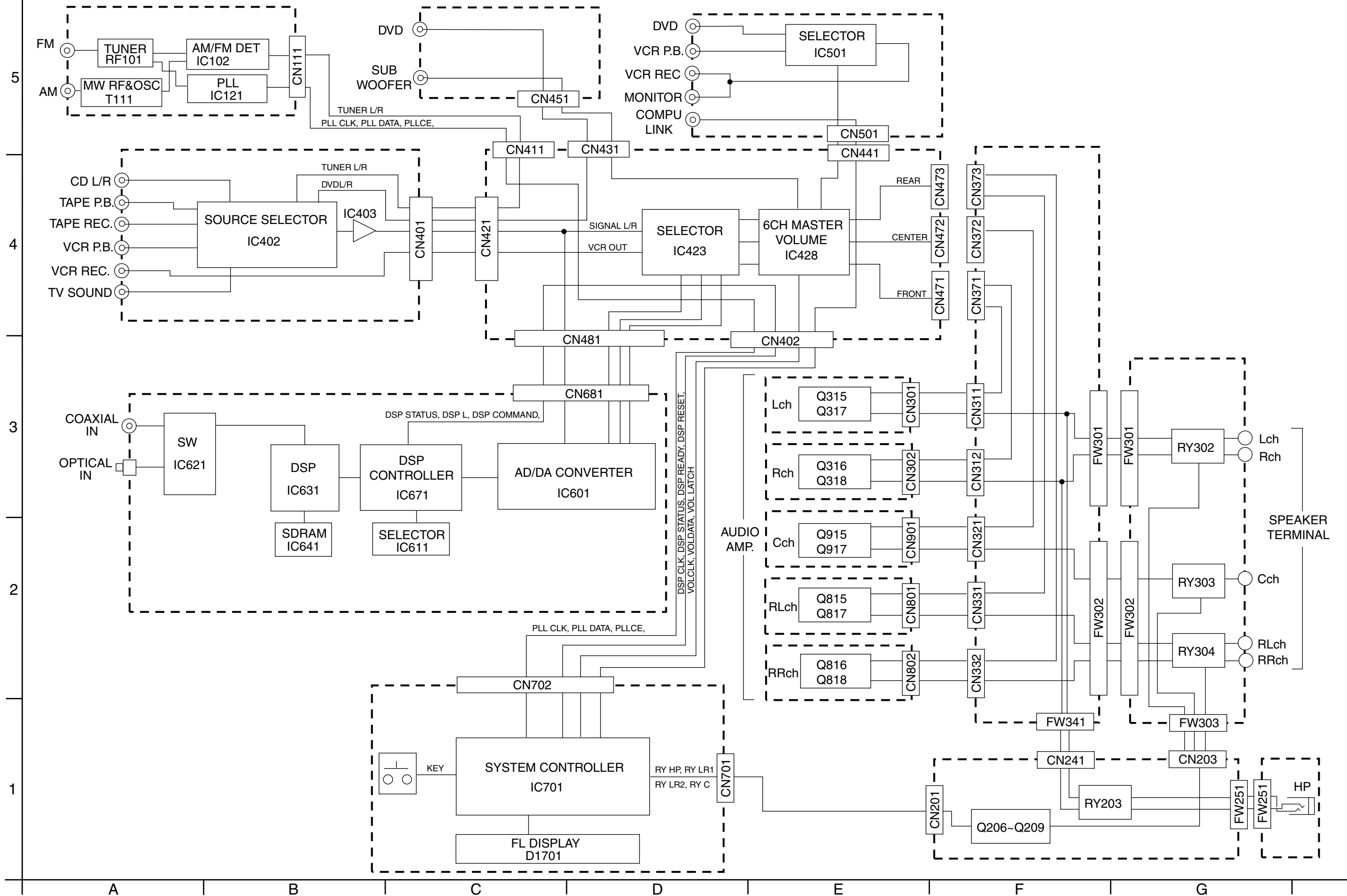

Standard schematic diagrams

Power supply section

US/UN/UY/UJ

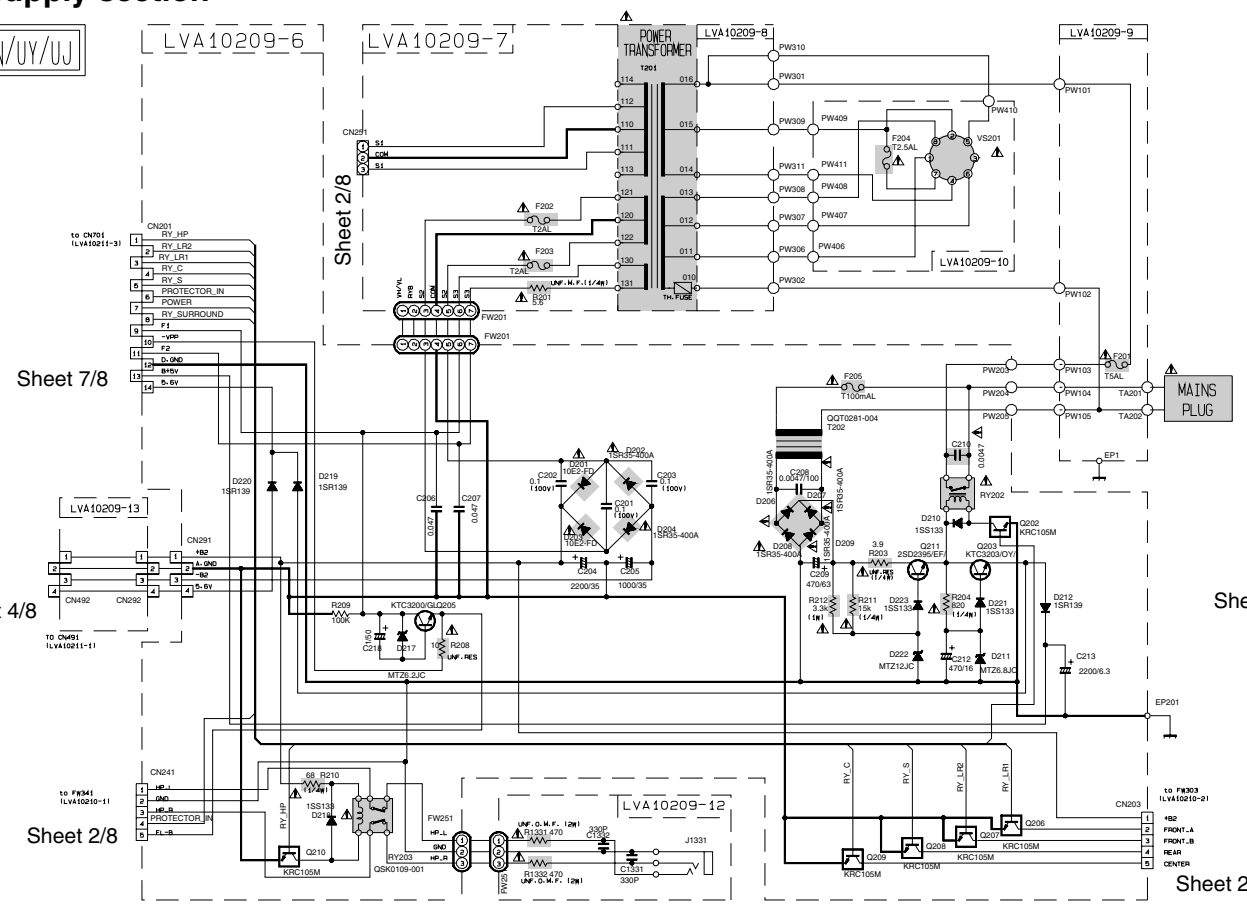

UP

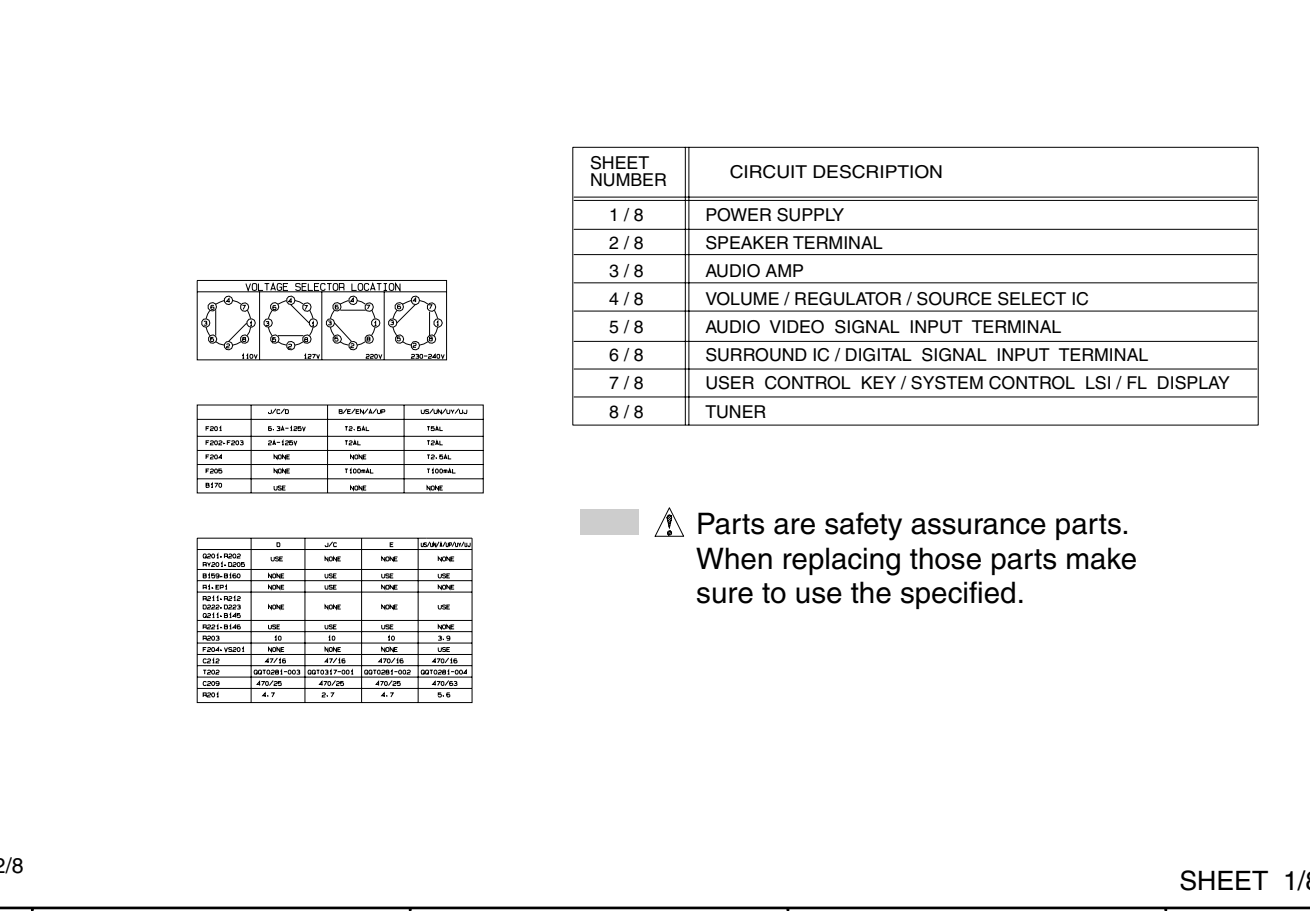
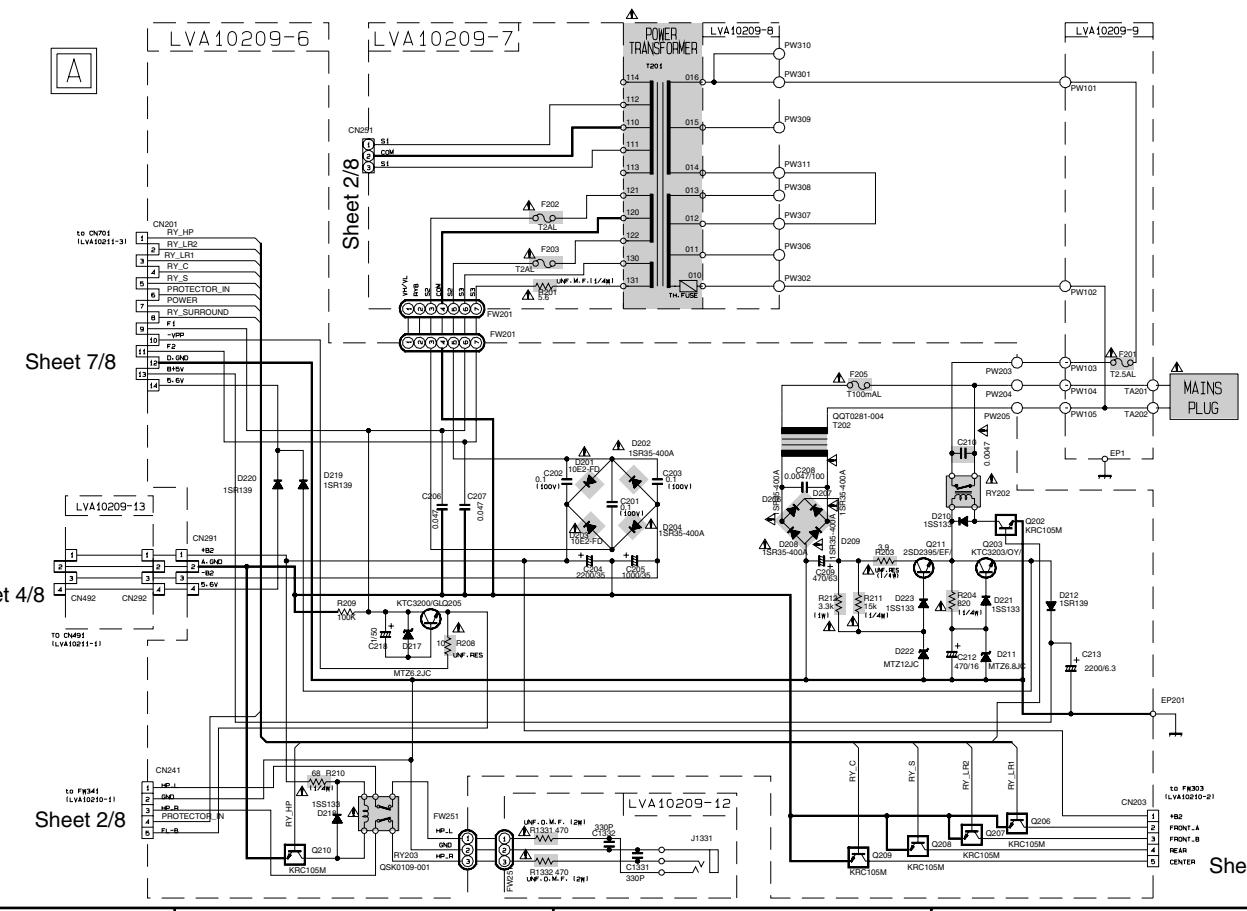
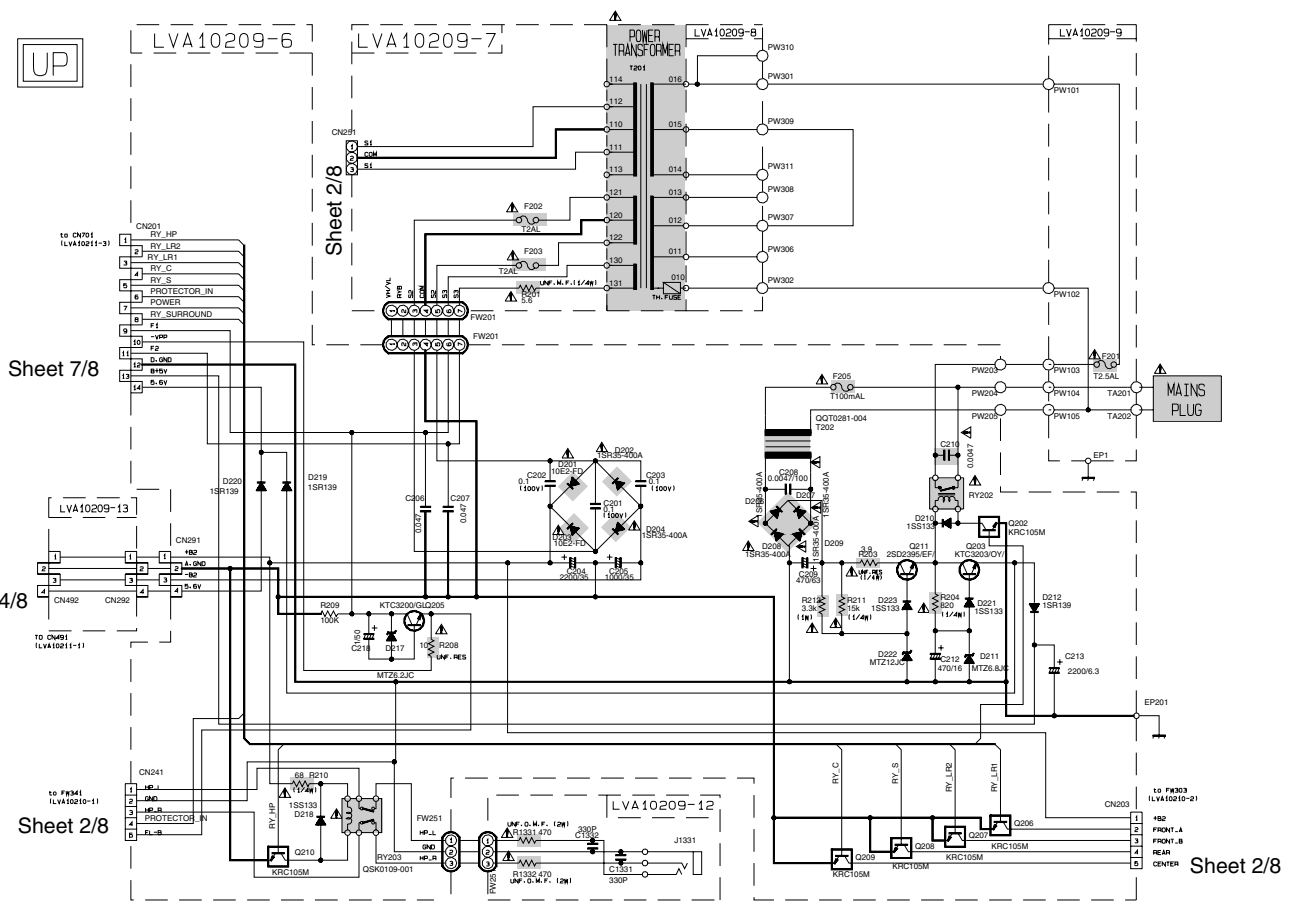

SHEET NUMBER	CIRCUIT DESCRIPTION
1 / 8	POWER SUPPLY
2 / 8	SPEAKER TERMINAL
3 / 8	AUDIO AMP
4 / 8	VOLUME / REGULATOR / SOURCE SELECT IC
5 / 8	AUDIO VIDEO SIGNAL INPUT TERMINAL
6 / 8	SURROUND IC / DIGITAL SIGNAL INPUT TERMINAL
7 / 8	USER CONTROL KEY / SYSTEM CONTROL LSI / FL DISPLAY
8 / 8	TUNER

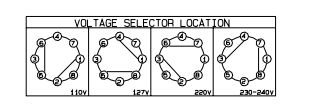

FUSE	J/C/D	B/E/EN/A/UP	US/UN/UY/UJ
F201	6.3A-125V	T2-BAL	TSAL
F202-F203	2A-125V	T2AL	T2AL
F204	NONE	NONE	T2-BAL
F205	NONE	1100uAL	1100uAL
R170	USE	NONE	NONE

D	J/C	E	US/UN/UY/UJ
D011-R202	USE	NONE	NONE
R201-D202	USE	USE	USE
B155-B160	NONE	USE	USE
R11-EP1	NONE	USE	NONE
R11-R12	NONE	NONE	USE
D204-D203	NONE	NONE	USE
D11-D12	USE	USE	NONE
R201-B145	USE	USE	NONE
R203	10	10	10
T204-V201	NONE	NONE	USE
C212	47/16	47/16	470/16
T202	00T0281-003	00T0317-001	00T0281-004
D209	470/25	470/25	470/25
R201	4.7	4.7	4.7

Parts are safety assurance parts. When replacing those parts make sure to use the specified.

Audio & Speaker terminal section

5
4
3
2
1

Sheet 3/8
Sheet 4/8

Sheet 1/8

LVA10210-1

FW485
(LVA10211-1)
Sheet 4/8

LVA10210-2

Sheet 1/8

Sheet 1/8

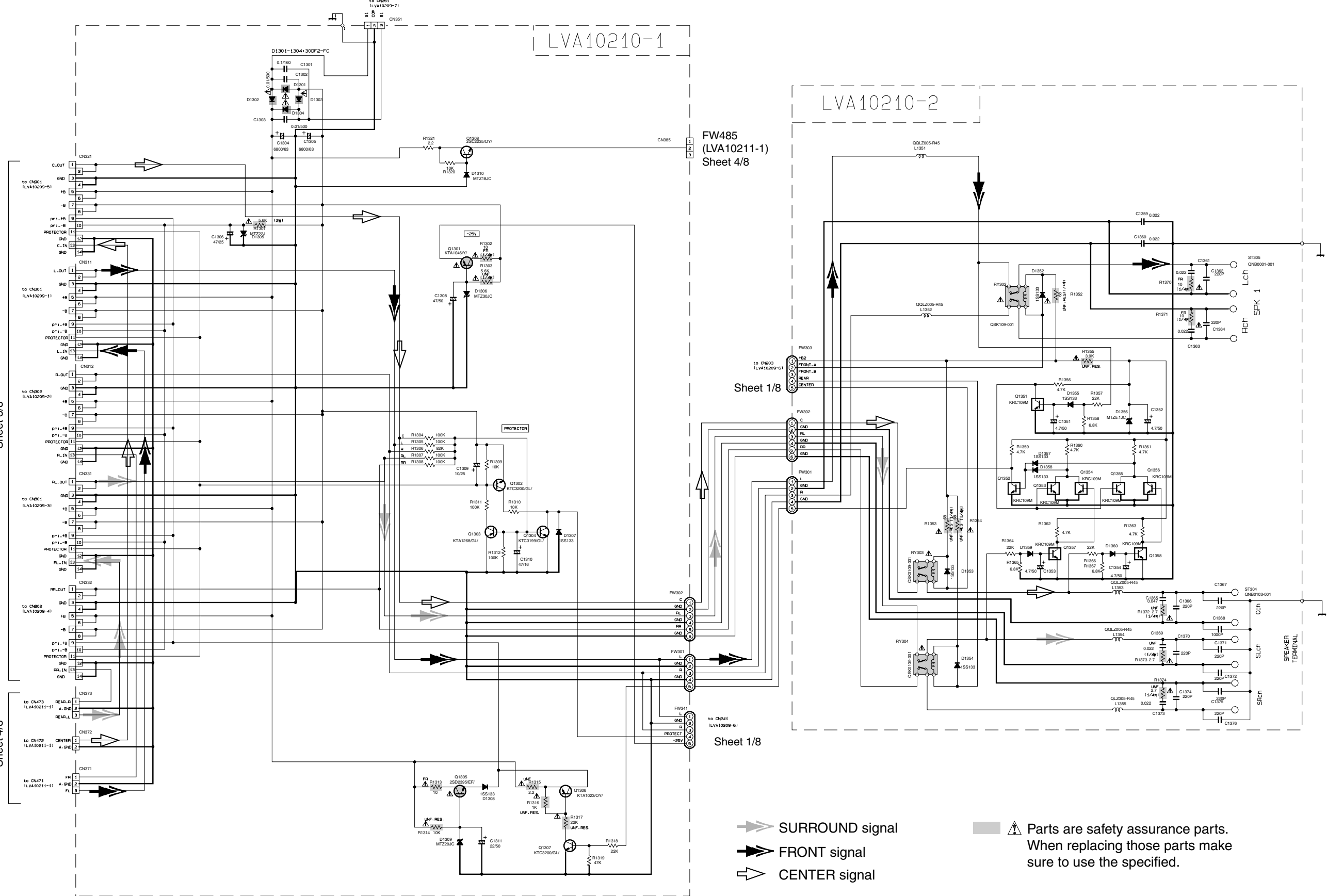

- SURROUND signal
- FRONT signal
- CENTER signal
- Parts are safety assurance parts. When replacing those parts make sure to use the specified.

Audio amplifier section

5

4

3

2

1

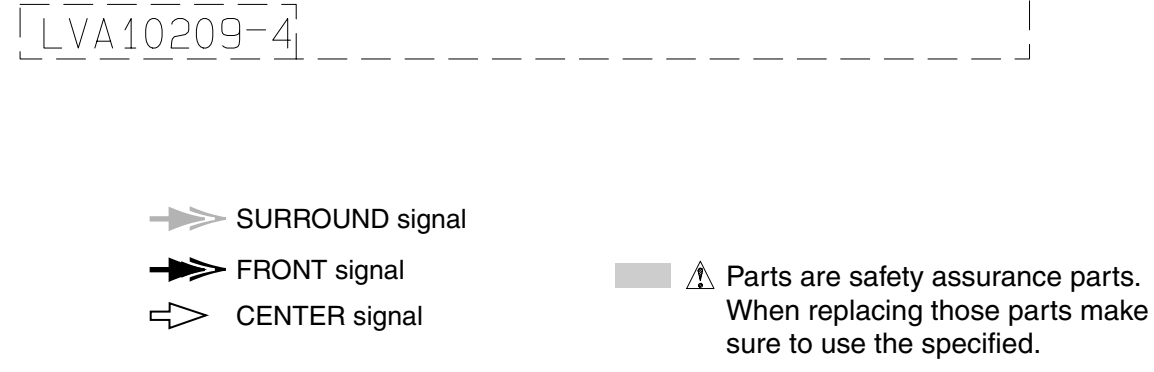
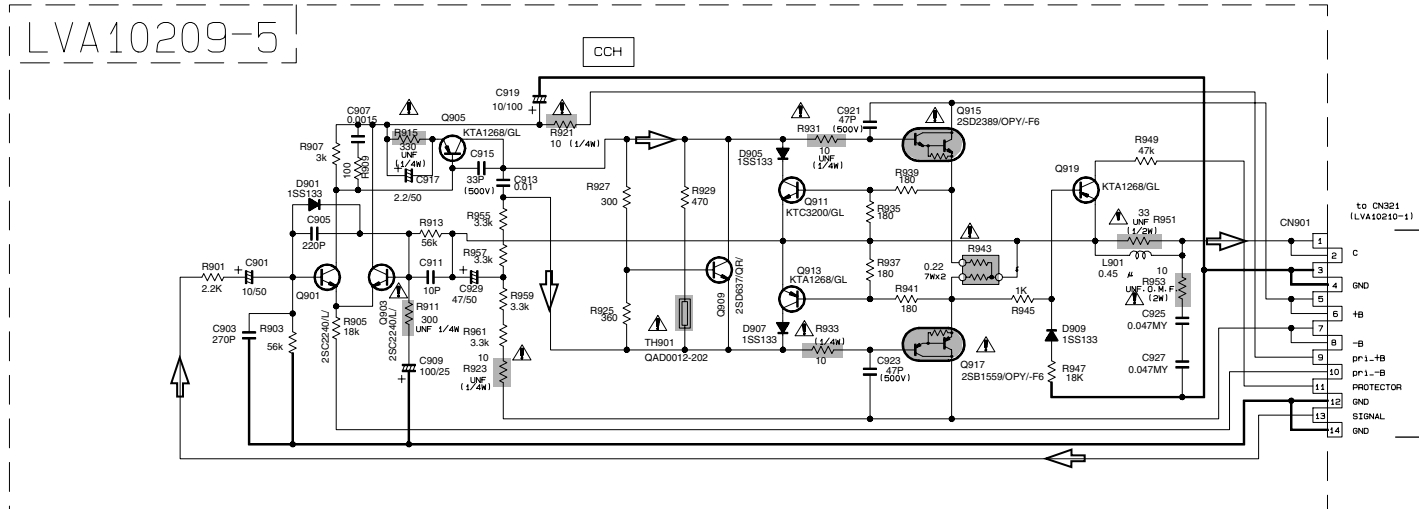
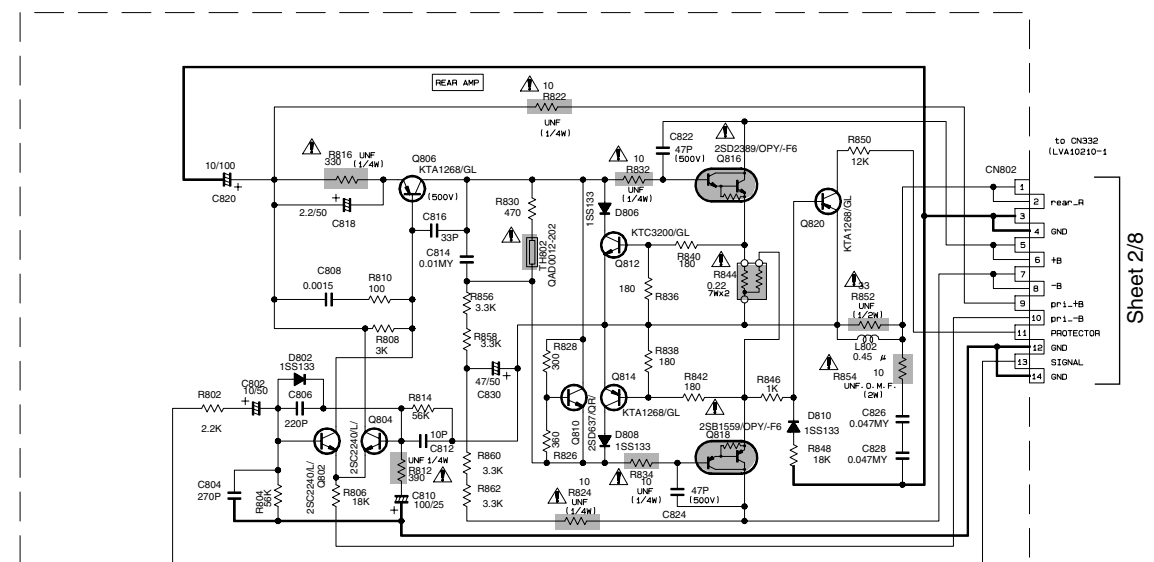
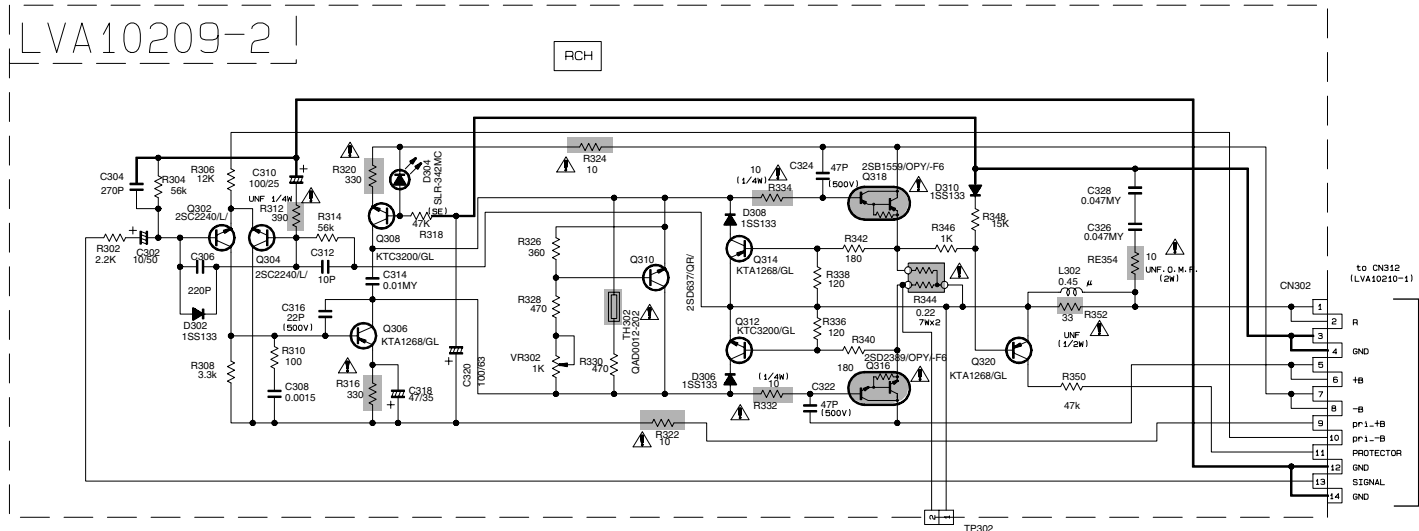
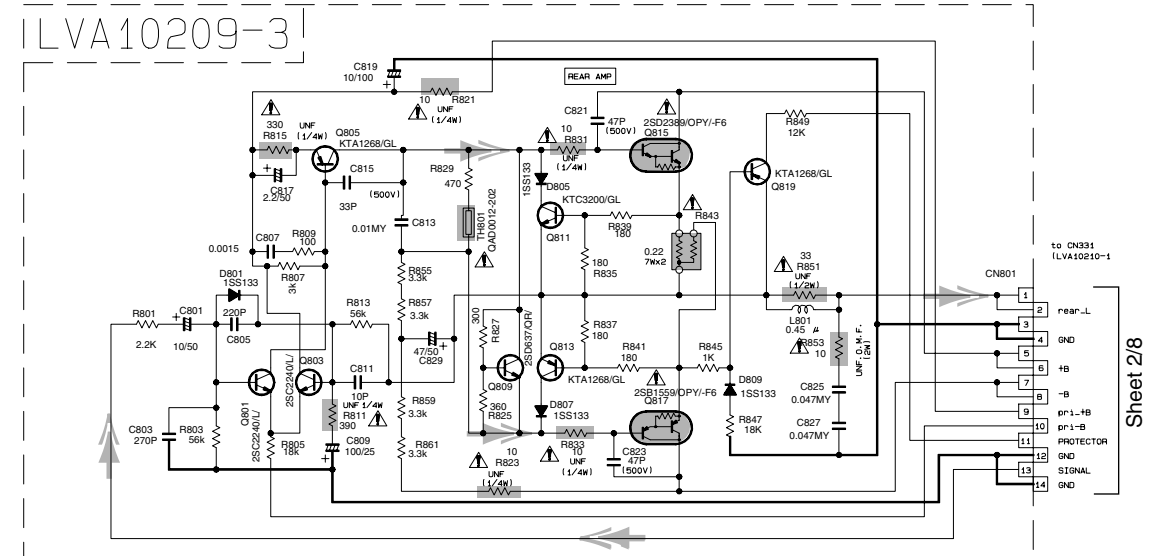
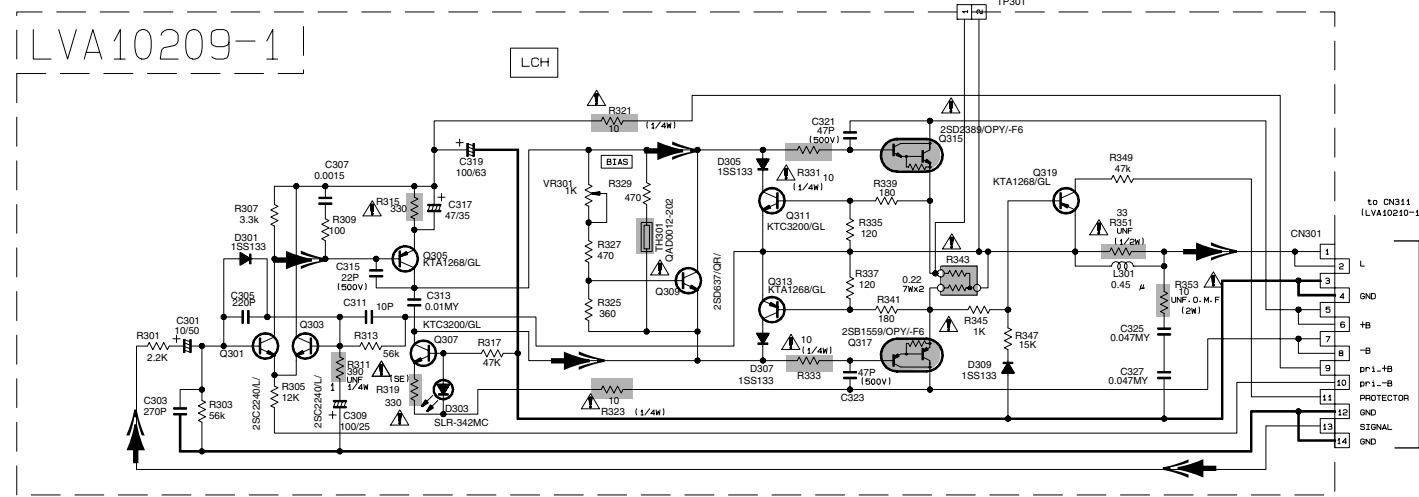

- ➔ SURROUND signal
- ➔ FRONT signal
- ➔ CENTER signal
- ⚠ Parts are safety assurance parts. When replacing those parts make sure to use the specified.

■ Main section

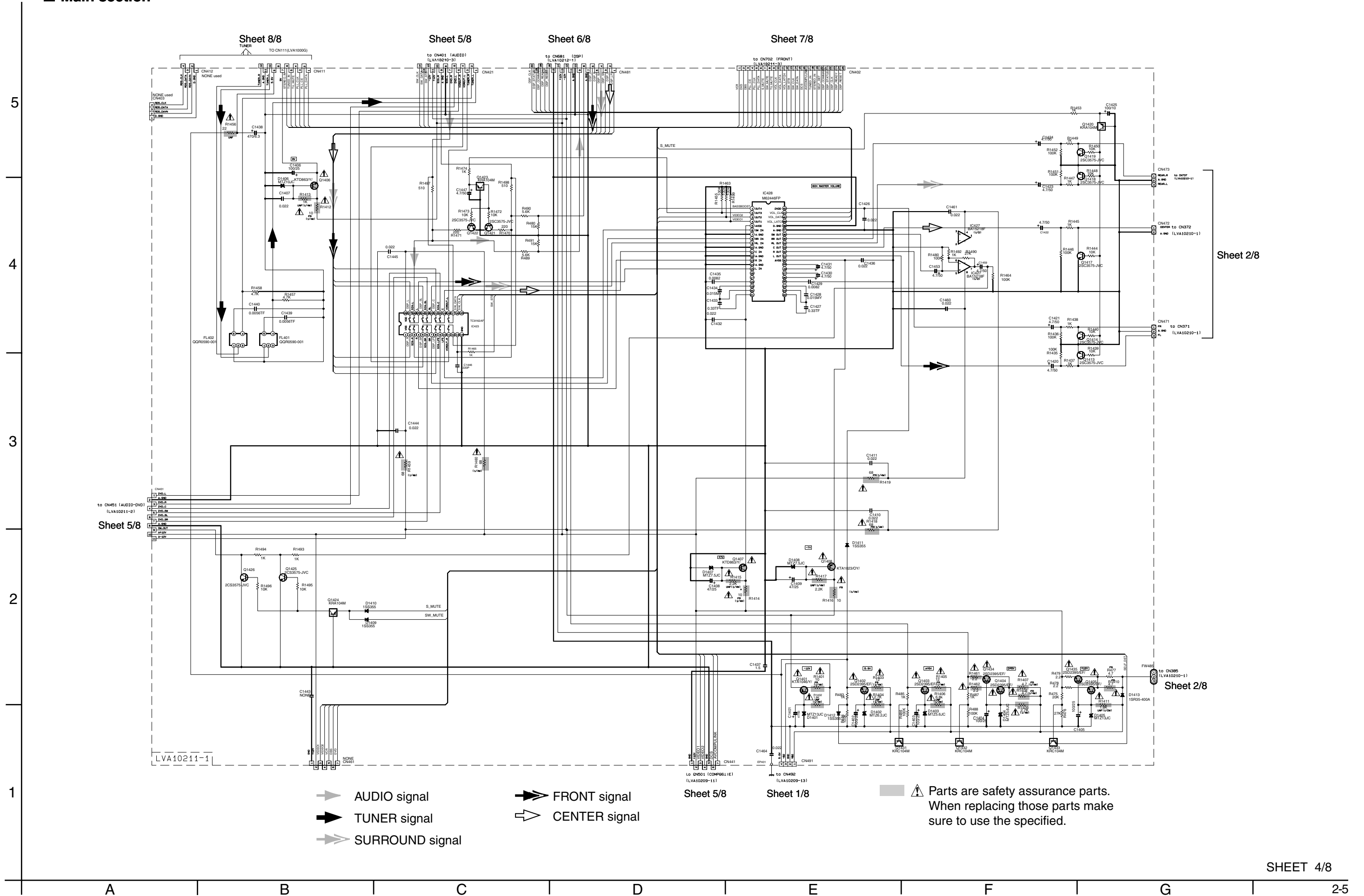

■ Audio / Video / DVD signal input section

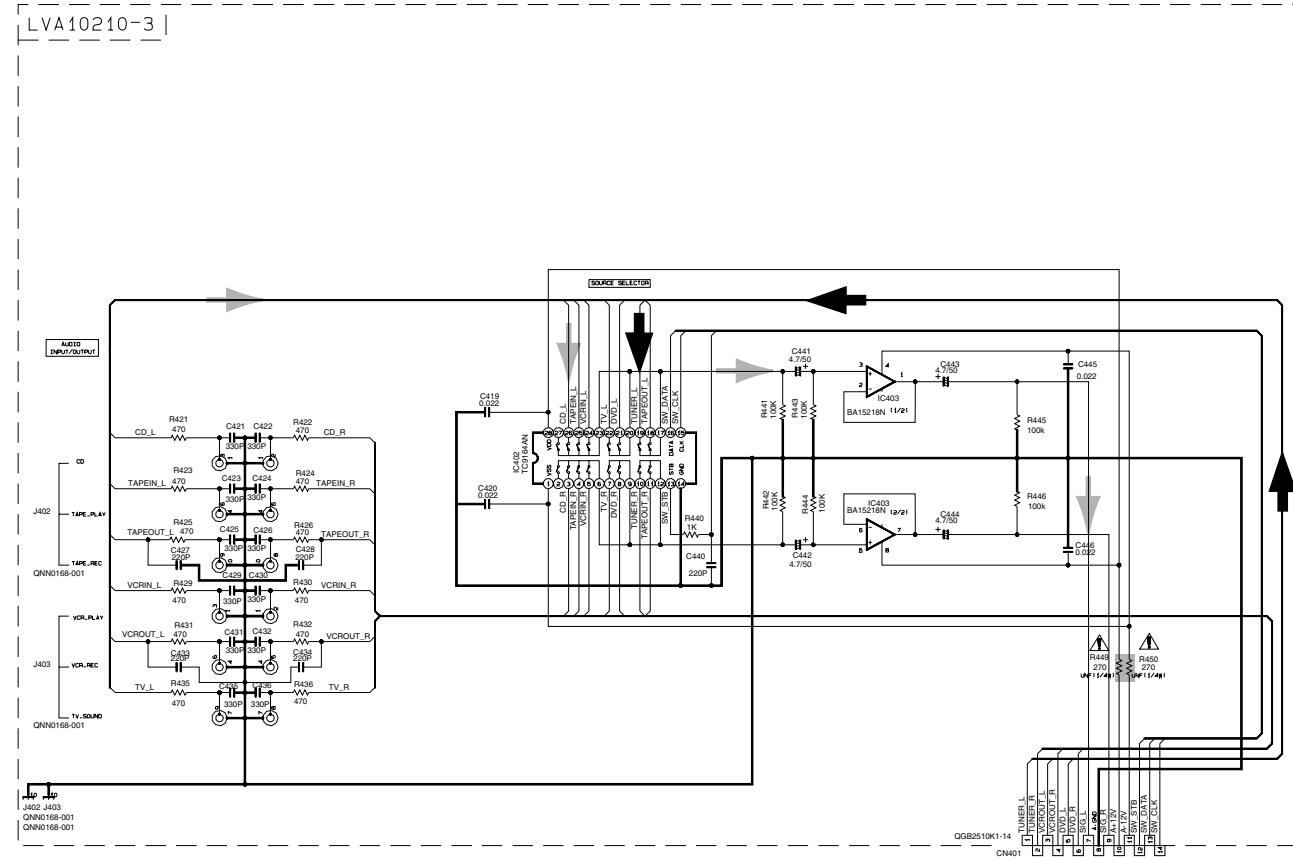

Sheet 4/8

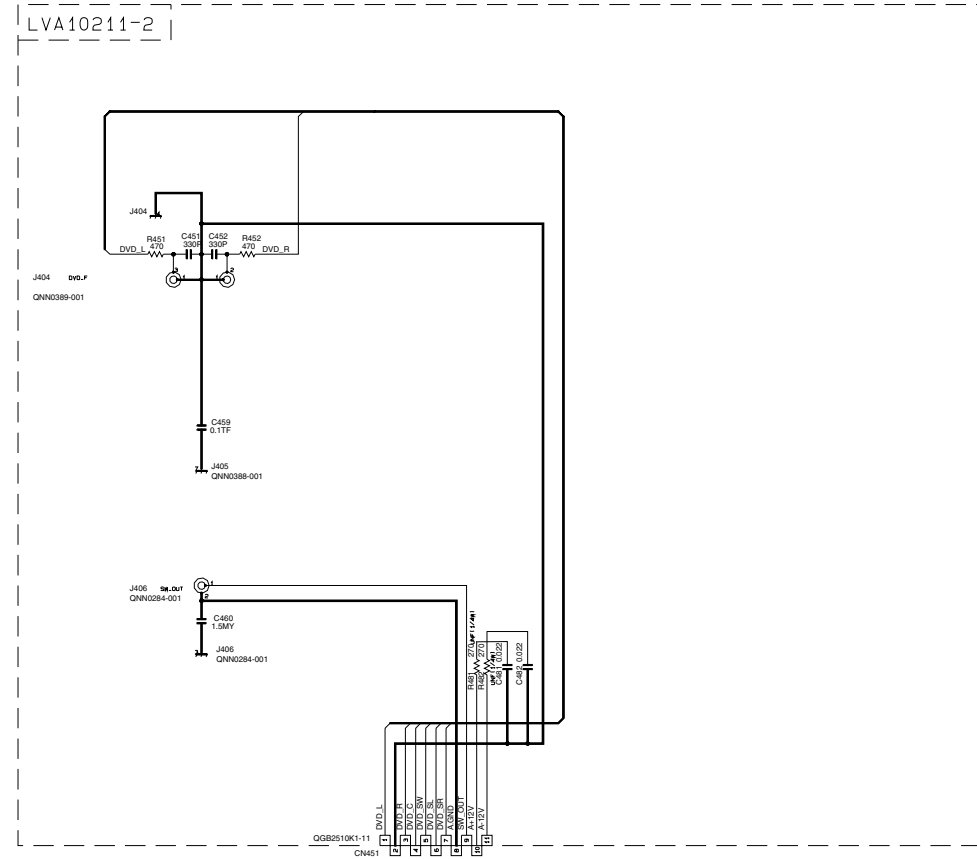

Sheet 4/8

	RX-6010	RX-7010
J401	NONE	USE
J405	NONE	USE
J503	NONE	USE
J591	NONE	USE

	RX-6010	RX-7010
D	J/C/E/U	ALL-Ver.
J551	USE	NONE
J552	USE	NONE
J553	NONE	USE

AUDIO signal
 TUNER signal

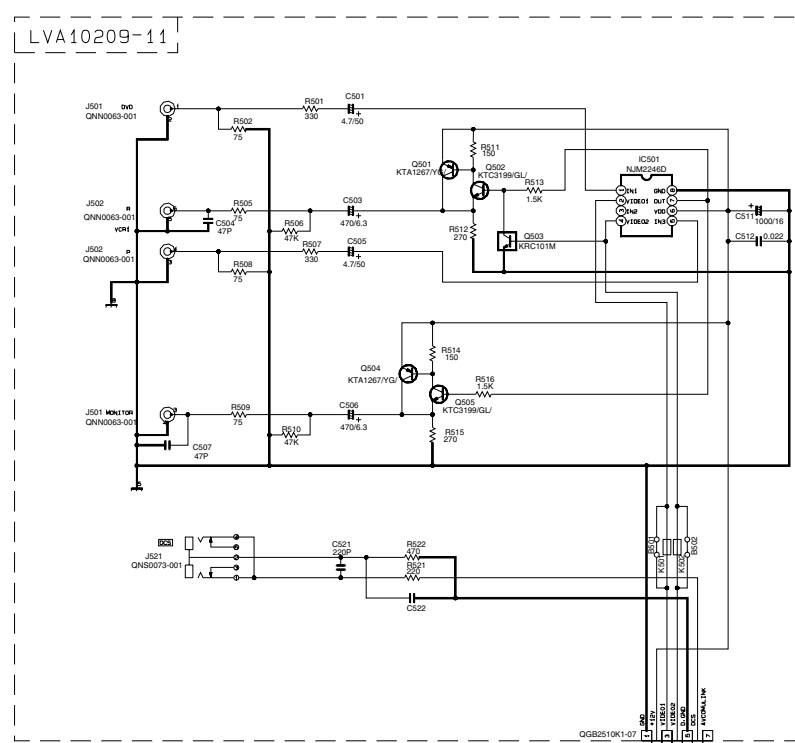

Sheet 4/8

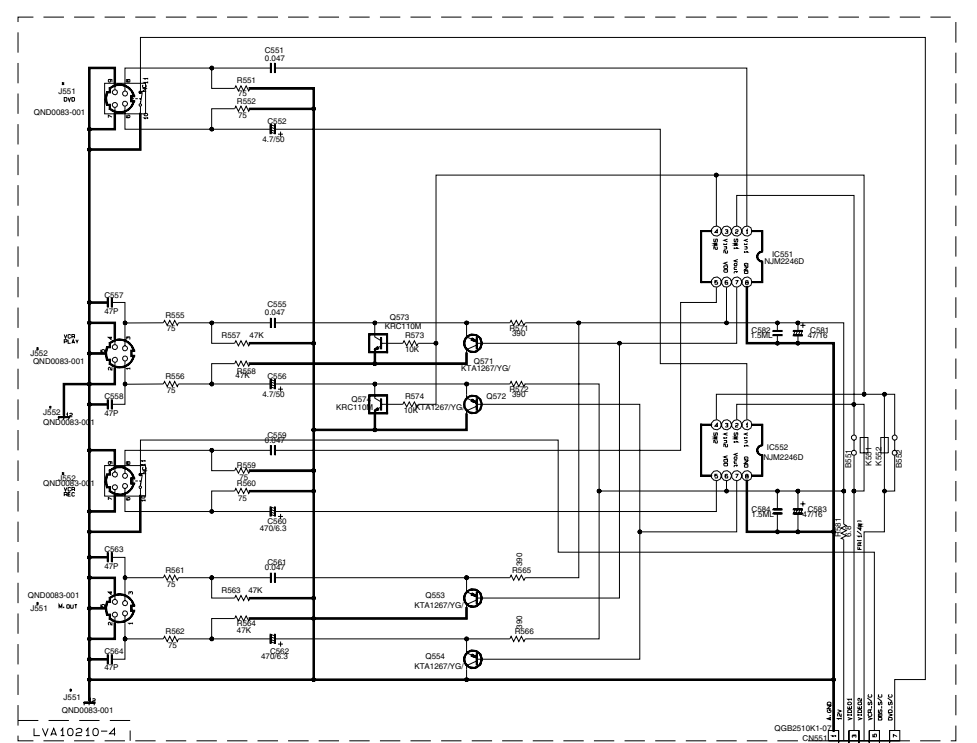

Parts are safety assurance parts.
 When replacing those parts make sure to use the specified.

System control and FL displaying section

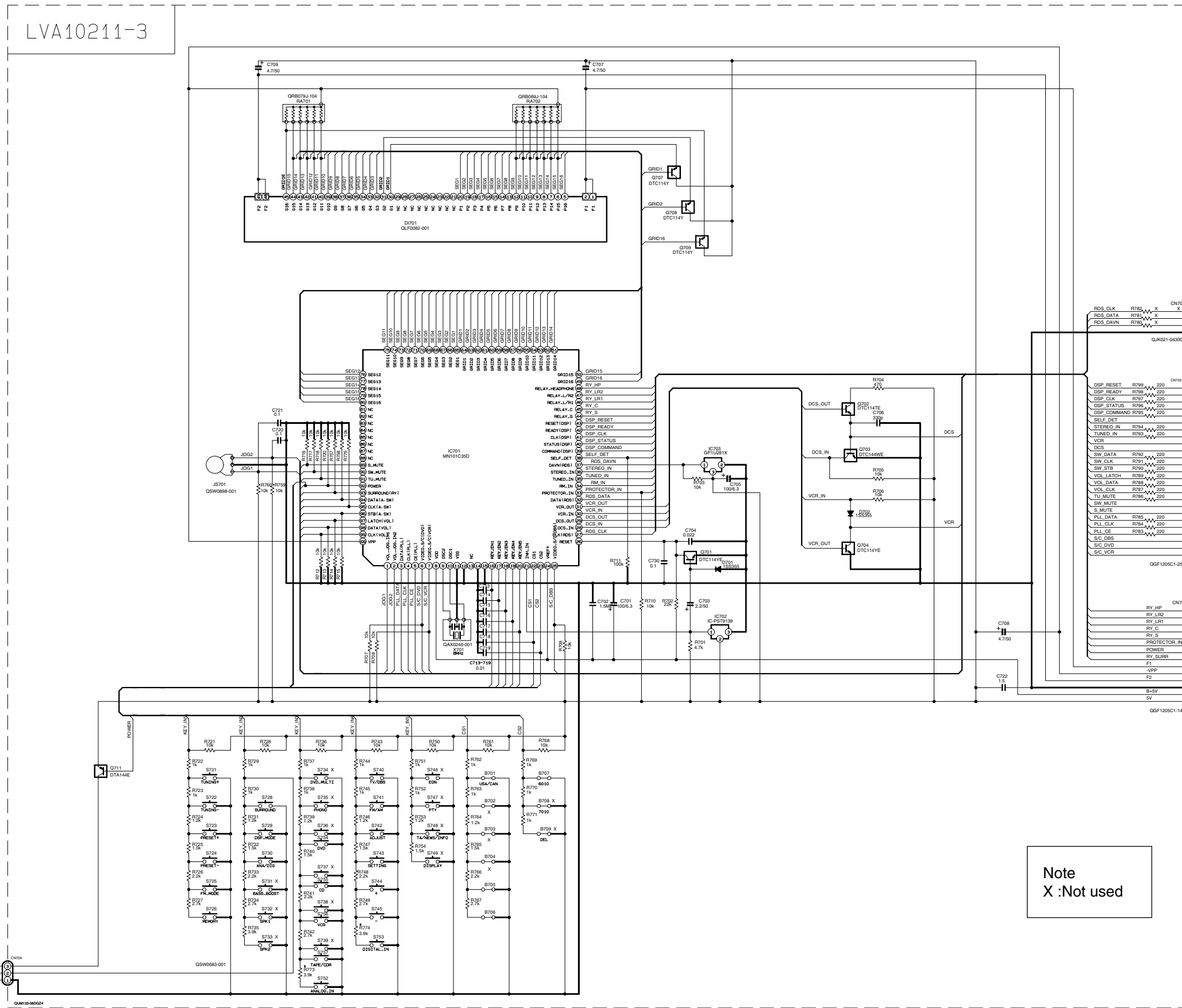

Note
X :Not used

Sheet 4/8

Sheet 1/8

■ Tuner section

FOR J, C, U, A

LVA10009

5

4

3

2

1

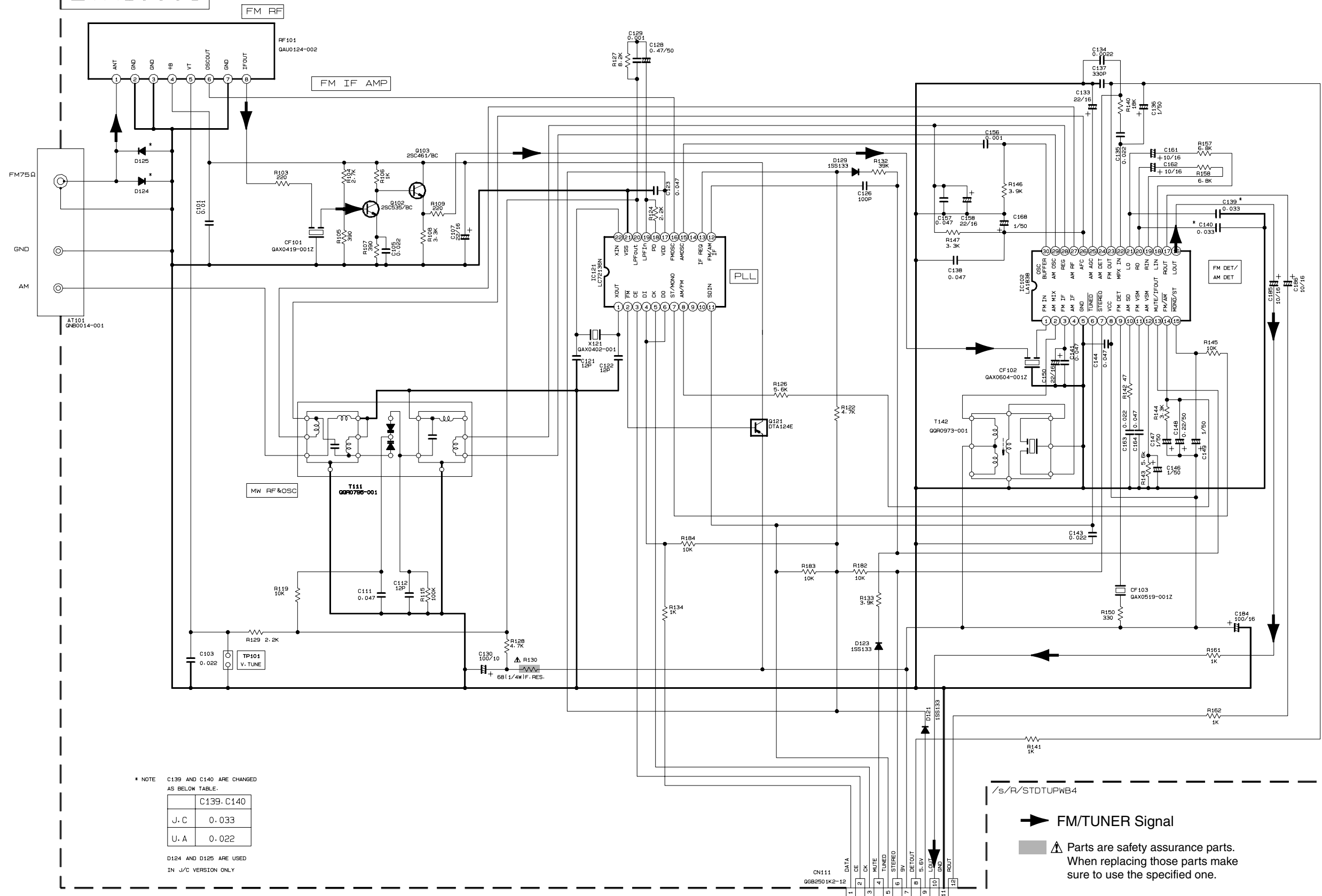

* NOTE C139 AND C140 ARE CHANGED AS BELOW TABLE.

	C139, C140
J, C	0.033
U, A	0.022

D124 AND D125 ARE USED IN J/C VERSION ONLY

/s/R/STDUPWB4

- ➔ FM/TUNER Signal
- ⚠ Parts are safety assurance parts. When replacing those parts make sure to use the specified one.

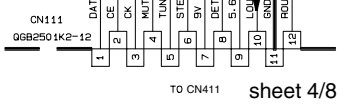

TO CN411 sheet 4/8

Printed circuit boards

■ Main board

5
4
3
2
1

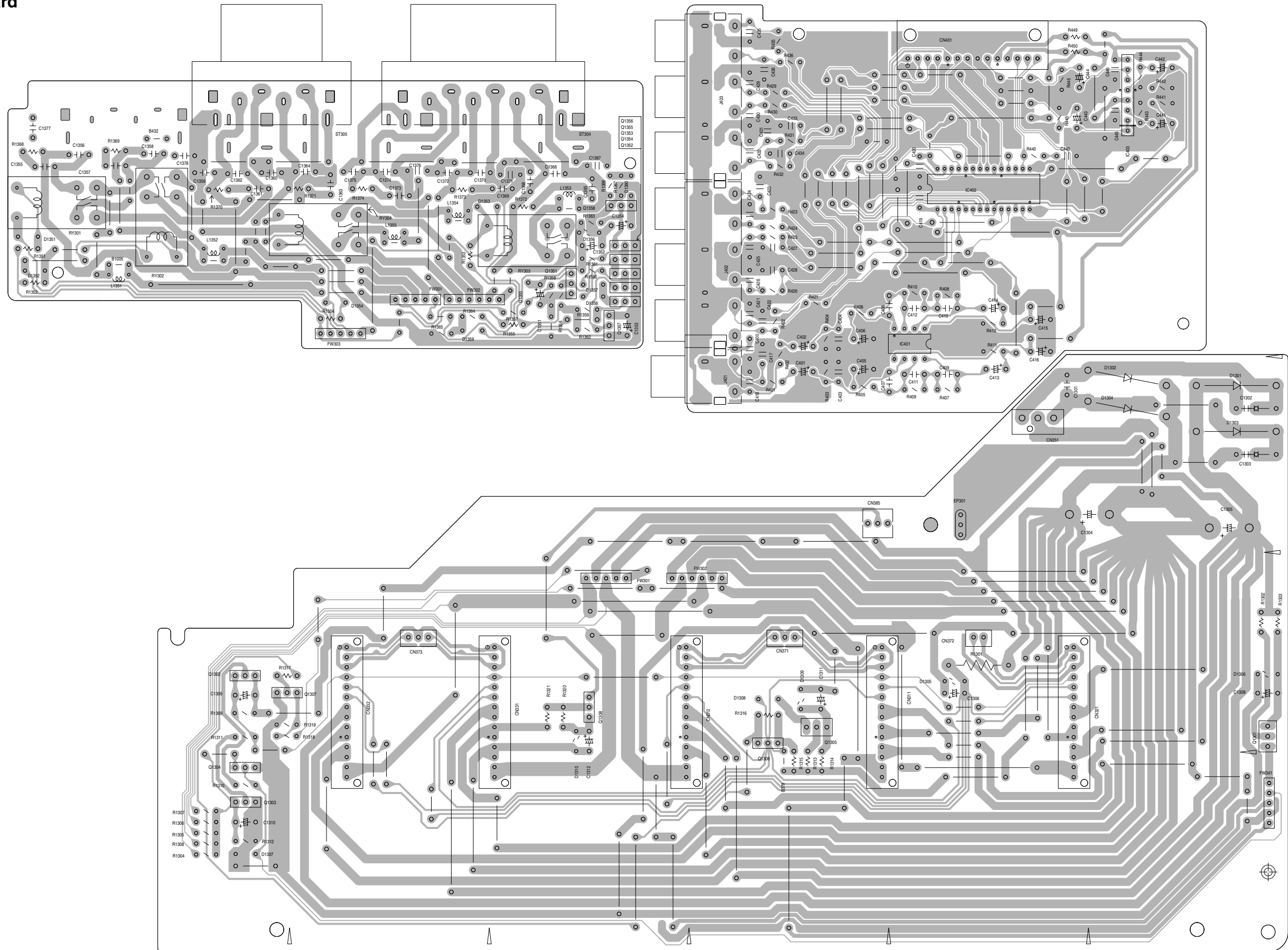

A B C 2-10 D E F G H

■ System control & Audio board

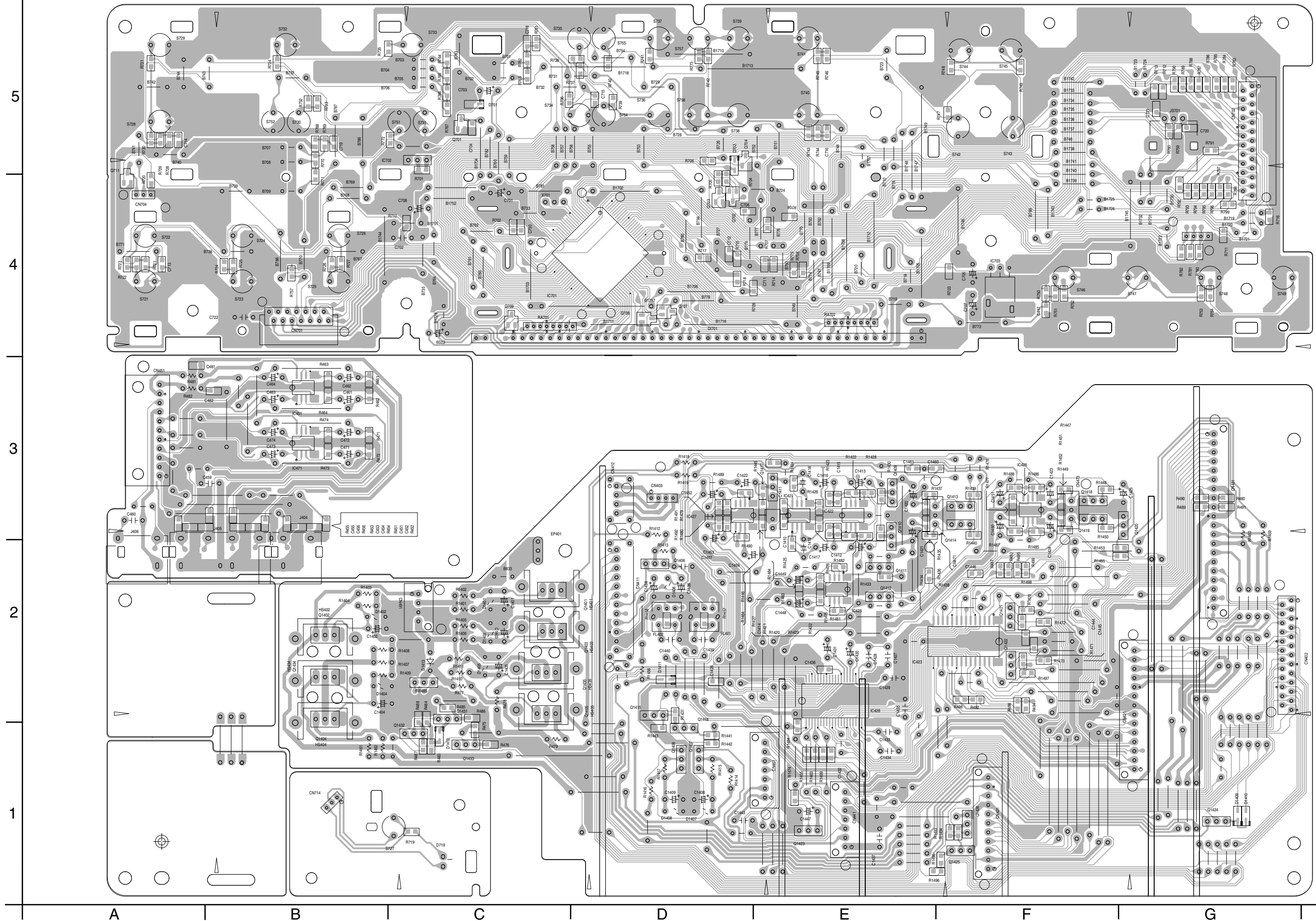

Power amp. board

5

4

3

2

1

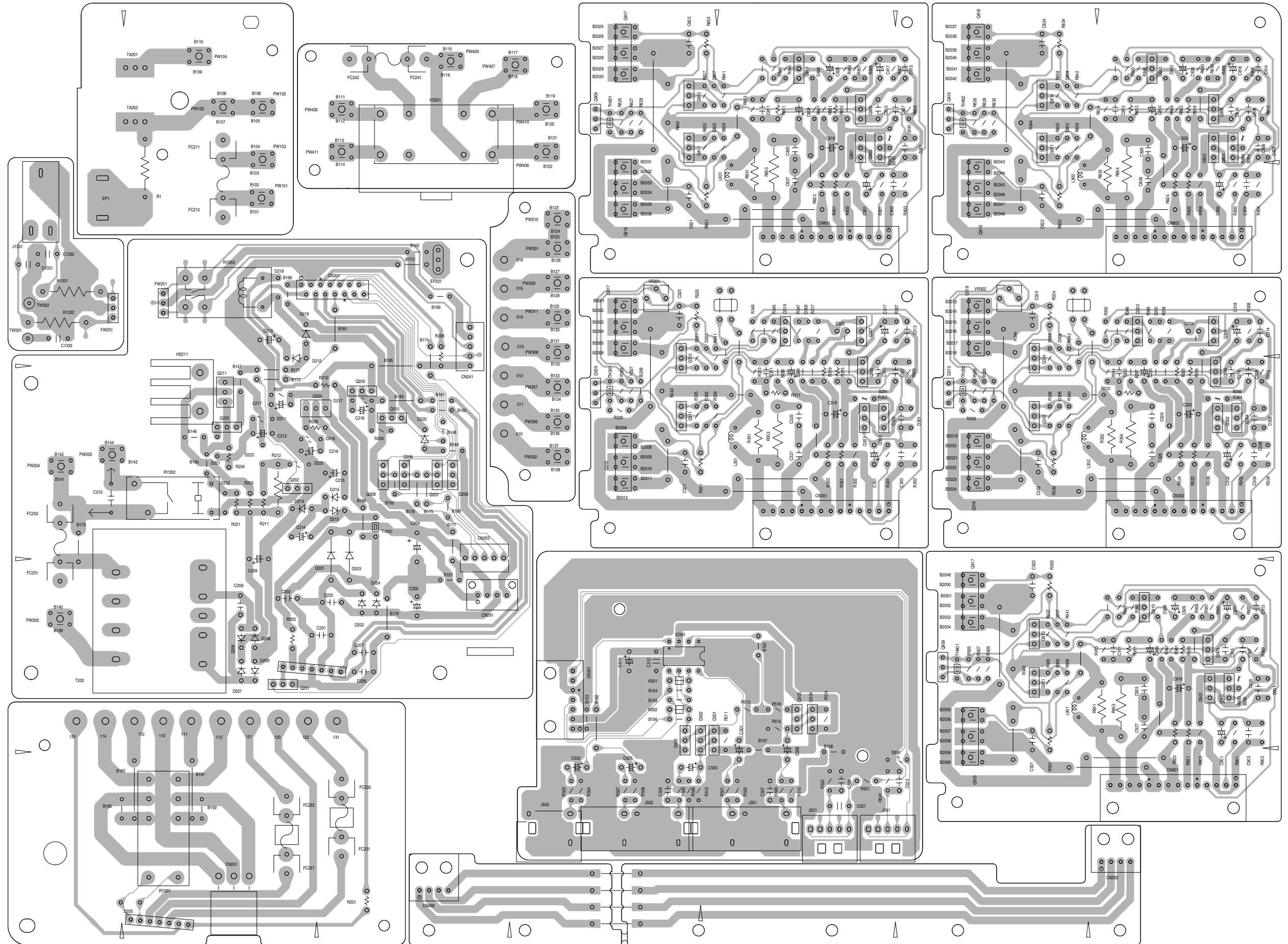

■ Tuner board

5
4
3
2
1

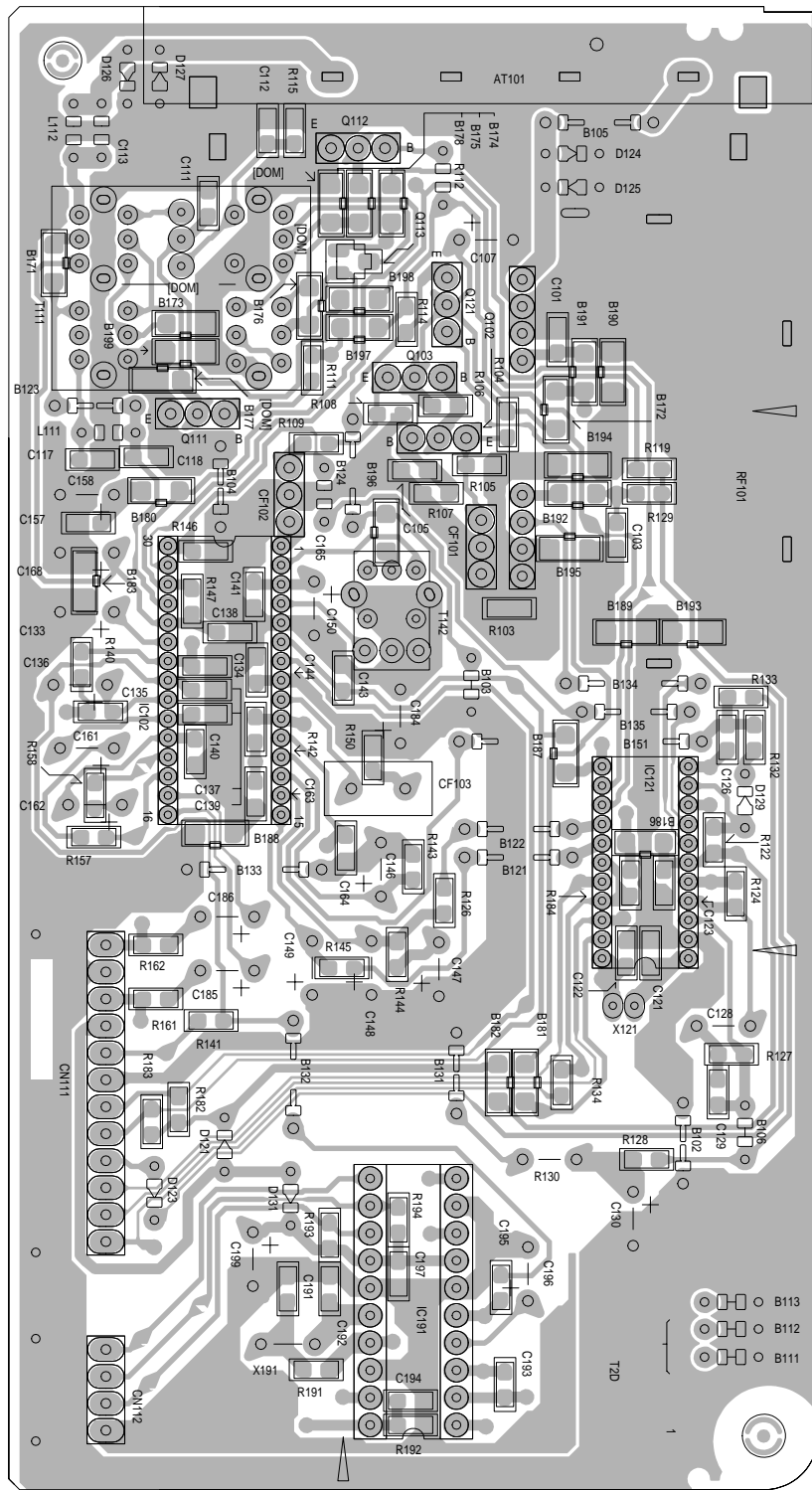

A B C D

PARTS LIST

[RX-6010VBK]
[RX-6012VSL]

* All printed circuit boards and its assemblies are not available as service parts.

RX-6010VBK	
Area suffix	
UJ -----	U.S.Military

RX-6012VSL	
Area suffix	
A -----	Australia
UP -----	Korea
US -----	Singapore
UY -----	Argentina

- Contents -

Exploded view of general assembly and parts list	3- 3
Electrical parts list	3- 5
Packing materials and accessories parts list	3-18

< M E M O >

Exploded view of general assembly and parts list

Block No. **M 1 M M**

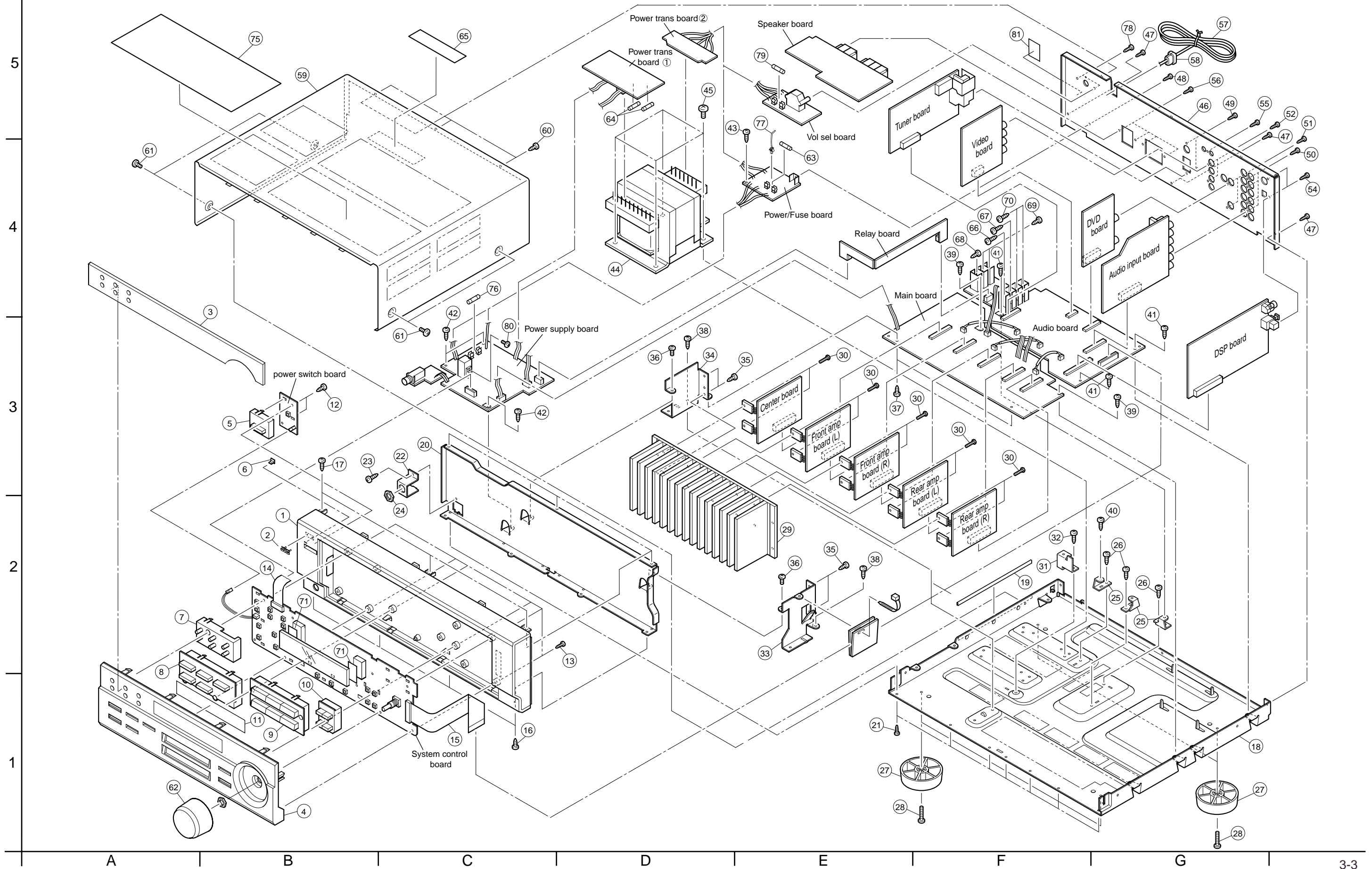

■ Parts list (General assembly)

Block No. M1MM

△	Item	Parts number	Parts name	Q'ty	Description	Area
	1	LV10457-008A	FRONT PANEL	1	RX-6010VBK	
		LV10457-011A	FRONT PANEL	1	RX-6012VSL	
	2	VJD5429-002SS	JVC MARK	1	RX-6012VSL	
		VJD5429-001SS	JVC MARK	1	RX-6010VBK	
	3	LV20949-002A	LENS	1		
	4	LV10459-004A	SUB PANEL	1	RX-6012VSL	
		LV10459-003A	SUB PANEL	1	RX-6010VBK	
	5	LV32431-002A	POWER BUTTON	1	RX-6012VSL	
		LV32431-004A	POWER BUTTON	1	RX-6010VBK	
	6	LV42096-001A	INDICATOR	1	POWER	
	7	LV20951-001A	PUSH BUTTON	1	TUNER	
	8	LV20919-004A	PUSH BUTTON(C)	1	RX-6012VSL	
		LV20919-003A	PUSH BUTTON(C)	1	RX-6010VBK	
	9	LV20918-002A	PUSH BUTTON(E)	1	RX-6012VSL	
		LV20918-001A	PUSH BUTTON(E)	1	RX-6010VBK	
	10	LV32430-001A	PUSH BUTTON(F)	1	RX-6010VBK	
		LV32430-002A	PUSH BUTTON(F)	1	RX-6012VSL	
	11	LV42095-001A	FL SCREEN	1		
	12	QYSBSF2610Z	SCREW	2	FRONT C.B	
	13	QYSBSF2610Z	SCREW	6	FRONT C.B FL	
	14	QUQ412-1415CJ	FFC WIRE	1		
	15	QUQ412-2538CJ	FFC WIRE	1		
	16	QYSDSG3006Z	SCREW	4	FRONT D	
	17	QYSBSG3006Z	T.SCREW	3	FRONT U	
	18	LV10019-003A	CHASSIS BASE	1		
	19	EXO150010H09S11	FELT SPACER	1	FOR C.BASE	
	20	LV10458-002A	FRONT BRACKET	1		
	21	QYSDSG3006Z	SCREW	7	C.B-F.B	
	22	LV42094-002A	H.P. BKT	1		
	23	QYSBSG3006Z	T.SCREW	1	H.P BKT-F.B	
	24	VKZ4150-001	SPECIAL NUT	1		
	25	E68587-223SM	CB BKT	3		
	26	QYSBST3006Z	T.SCREW	3	C.B-BKT	
	27	QZF6018-001	FOOT	4	RX-6010VBK	
		QZF6018-003	FOOT	4	RX-6012VSL	
	28	QYSBST3010Z	T.SCREW	4	FOOT	
	29	LV20916-002A	HEAT SINK	1		
	30	E73525-003SS	SCREW	10	TR	
	31	LV42098-001A	C.B BKT	1	PRI/SEC C.B	
	32	QYSBST3006Z	T.SCREW	1	C.B BKT	
	33	LV32433-001A	H.S BRACKET(R)	1		
	34	LV32434-001A	H.S BRACKET(L)	1		
	35	QYSBSG3008Z	T.SCREW	4	H.S-BKT	
	36	QYSBSG3006Z	T.SCREW	2	H.S BKT-F.BKT	
	37	QYSBSG3006Z	T.SCREW	2	H.S BKT	
	38	QYSBST3006Z	T.SCREW	2	H.S BKT-CHASSIS	
	39	QYSBSG3006Z	T.SCREW	2	M.C.B	
	40	E65923-003	TAPPING SCREW	1	M.C.B	

■ Parts list (General assembly)

Block No. M1MM

△	Item	Parts number	Parts name	Q'ty	Description	Area
	41	QYSBSG3006Z	T.SCREW	3	H.S-C.B	
	42	QYSBSG3006Z	T.SCREW	3	P.C.B-CHASSIS	
	43	QYSBSG3006Z	T.SCREW	1	C.B-CHASSIS	
△	44	QQT0283-001	TRANSFORMER	1		
	45	QYSDSTL4008Z	SPECIAL SCREW	4	P.TRANS	
	46	LV20915-008A	REAR PANEL	1	RX-6010VBK	UJ
		LV20915-016A	REAR PANEL	1	RX-6012VSL	UP
		LV20915-011A	REAR PANEL	1	RX-6012VSL	US, UY
		LV20915-015A	REAR PANEL	1	RX-6012VSL	A
	47	QYSBSGY3008M	SPECIAL SCREW	3	R.P-C.BASE	
	48	QYSBSGY3008M	SPECIAL SCREW	1	R.P-ud---	
	49	QYSBSGY3008M	SPECIAL SCREW	2	TUNER	
	50	QYSBSGY3008M	SPECIAL SCREW	4	INPUT	
	51	QYSBSGY3008M	SPECIAL SCREW	2	V AUDIO	
	52	QYSBSGY3008M	SPECIAL SCREW	2	VIDEO	
	54	QYSBSGY3008M	SPECIAL SCREW	2	DIGITAL	
	55	QYSBSGY3008M	SPECIAL SCREW	1	COMP C.B	
	56	QYSBSGY3008M	SPECIAL SCREW	4	SPK C.B	
△	57	QMPG040-244-JD	POWER CORD	1	RX-6012VSL	A
△		QMPK150-200-JD	POWER CORD	1	RX-6010VBK	UJ
△		QMPR160-200-JC	POWER CORD	1	RX-6012VSL	UY
△		QMPK150-200-JD	POWER CORD	1	RX-6012VSL	US
△		EMP7000-200	POWER CORD	1	RX-6012VSL	UP
△	58	QZW0033-001	STRAIN RELIEF	1		
	59	LE20131-010A/S/	TOP COVER	1	RX-6010VBK	
		LE20131-011A/S/	TOP COVER	1	RX-6012VSL	
	60	QYSBSGY3008M	SPECIAL SCREW	3		
	61	E406308-003	SPECIAL SCREW	4	RX-6010VBK	
		E406308-004	SPECIAL SCREW	4	RX-6012VSL	
	62	LV32435-004A	VOL KNOB	1	RX-6012VSL	
		LV32435-003A	VOLUME KNOB	1	RX-6010VBK	
△	63	QMF51E2-2R5-J1	FUSE(F201)	1	RX-6012VSL	US, UY
△		QMF51E2-5R0-J1	FUSE(F201)	1	RX-6012VSL	A, UP
△		QMF51E2-5R0-J1	FUSE(F201)	1	RX-6010VBK	UJ
△	64	QMF51E2-2R0-J1	FUSE	2	F202 F203	
	65	E409396-002	CAUTION LABEL	1		
	66	QYSBSG3008E	T.SCREW	1	Q1401	
	67	QYSBSG3008E	T.SCREW	1	Q1403	
	68	QYSBSG3008E	T.SCREW	1	Q1402	
	69	QYSBSG3008E	T.SCREW	2	Q1404 Q1434	
	70	QYSBSG3008E	T.SCREW	2	Q1405 Q1435	
	71	LV30225-097A	SPACER	2		
	75	LV30077-006A	PROTECT SHEET	1	RX-6012VSL	
		LV30077-004A	PROTECT SHEET	1	RX-6010VBK	
△	76	QMF51E2-R10-J1	FUSE	1	F205	
	77	E307572-001	FASTENER	1		
	78	QYSBSGY3008M	SPECIAL SCREW	2	RX-6012VSL	US, UY
		QYSBSGY3008M	SPECIAL SCREW	2	RX-6010VBK	UJ
△	79	QMF51E2-2R5-J1	FUSE(F204)	1	RX-6010VBK	UJ
△		QMF51E2-2R5-J1	FUSE(F204)	1	RX-6012VSL	US, UY
	80	QYSBSG3008E	T.SCREW	1	Q211	
	81	LV30262-001A	UP LABEL	1	RX-6012VSL	UP

■ Electrical parts list (Power amp board)

Block No. 01

△	Item	Parts number	Parts name	Remarks	Area	△	Item	Parts number	Parts name	Remarks	Area	
	C 201	QFLC2AJ-104Z	M CAPACITOR	.10MF 5% 100V			C 813	QFLC1HJ-103Z	M CAPACITOR	.010MF 5% 50V		
	C 202	QFLC2AJ-104Z	M CAPACITOR	.10MF 5% 100V			C 814	QFLC1HJ-103Z	M CAPACITOR	.010MF 5% 50V		
	C 203	QFLC2AJ-104Z	M CAPACITOR	.10MF 5% 100V			C 815	QCS32HJ-330Z	C CAPACITOR	33PF 5% 500V		
	C 204	QETM1VM-228	E CAPACITOR	2200MF 20% 35V			C 816	QCS32HJ-330Z	C CAPACITOR	33PF 5% 500V		
	C 205	QETM1VM-108	E CAPACITOR	1000MF 20% 35V			C 817	QEHR1HM-225Z	E CAPACITOR	2.2MF 20% 50V		
	C 206	QFLC1HJ-473Z	M CAPACITOR	.047MF 5% 50V			C 818	QEHR1HM-225Z	E CAPACITOR	2.2MF 20% 50V		
	C 207	QFLC1HJ-473Z	M CAPACITOR	.047MF 5% 50V			C 819	QEHR2AM-106Z	E CAPACITOR	10MF 20% 100V		
	C 208	QFLC2AJ-472Z	M CAPACITOR	4700PF 5% 100V			C 820	QEHR2AM-106Z	E CAPACITOR	10MF 20% 100V		
	C 209	QETN1JM-477Z	E CAPACITOR	470MF 20% 63V			C 821	QCS32HJ-470Z	C CAPACITOR	47PF 5% 500V		
△	C 210	QCZ9104-472	C CAPACITOR	4700PF			C 822	QCS32HJ-470Z	C CAPACITOR	47PF 5% 500V		
	C 212	QETN1CM-477Z	E CAPACITOR	470MF 20% 16V			C 823	QCS32HJ-470Z	C CAPACITOR	47PF 5% 500V		
	C 213	QETM0JM-228	E CAPACITOR	2200MF 20% 6.3V			C 824	QCS32HJ-470Z	C CAPACITOR	47PF 5% 500V		
	C 218	QETN1HM-105Z	E CAPACITOR	1.0MF 20% 50V			C 825	QFLC1HJ-473Z	M CAPACITOR	.047MF 5% 50V		
	C 301	QEHR1HM-106Z	E CAPACITOR	10MF 20% 50V			C 826	QFLC1HJ-473Z	M CAPACITOR	.047MF 5% 50V		
	C 302	QEHR1HM-106Z	E CAPACITOR	10MF 20% 50V			C 827	QFLC1HJ-473Z	M CAPACITOR	.047MF 5% 50V		
	C 303	QCS31HJ-271Z	C CAPACITOR	270PF 5% 50V			C 828	QFLC1HJ-473Z	M CAPACITOR	.047MF 5% 50V		
	C 304	QCS31HJ-271Z	C CAPACITOR	270PF 5% 50V			C 829	QETN1HM-476Z	E CAPACITOR	47MF 20% 50V		
	C 305	QCS31HJ-221Z	C CAPACITOR	220PF 5% 50V			C 830	QETN1HM-476Z	E CAPACITOR	47MF 20% 50V		
	C 306	QCS31HJ-221Z	C CAPACITOR	220PF 5% 50V			C 901	QEHR1HM-106Z	E CAPACITOR	10MF 20% 50V		
	C 307	QCB31HK-152Z	C CAPACITOR	1500PF 10% 50V			C 903	QCS31HJ-271Z	C CAPACITOR	270PF 5% 50V		
	C 308	QCB31HK-152Z	C CAPACITOR	1500PF 10% 50V			C 905	QCS31HJ-221Z	C CAPACITOR	220PF 5% 50V		
	C 309	QETN1EM-107Z	E CAPACITOR	100MF 20% 25V			C 907	QCB31HK-152Z	C CAPACITOR	1500PF 10% 50V		
	C 310	QETN1EM-107Z	E CAPACITOR	100MF 20% 25V			C 909	QETN1EM-107Z	E CAPACITOR	100MF 20% 25V		
	C 311	QCS31HJ-100Z	C CAPACITOR	10PF 5% 50V			C 911	QCS31HJ-100Z	C CAPACITOR	10PF 5% 50V		
	C 312	QCS31HJ-100Z	C CAPACITOR	10PF 5% 50V			C 913	QFLC1HJ-103Z	M CAPACITOR	.010MF 5% 50V		
	C 313	QFLC1HJ-103Z	M CAPACITOR	.010MF 5% 50V			C 915	QCS32HJ-330Z	C CAPACITOR	33PF 5% 500V		
	C 314	QFLC1HJ-103Z	M CAPACITOR	.010MF 5% 50V			C 917	QEHR1HM-225Z	E CAPACITOR	2.2MF 20% 50V		
	C 315	QCS32HJ-220Z	C CAPACITOR	22PF 5% 500V			C 919	QEHR2AM-106Z	E CAPACITOR	10MF 20% 100V		
	C 316	QCS32HJ-220Z	C CAPACITOR	22PF 5% 500V			C 921	QCS32HJ-470Z	C CAPACITOR	47PF 5% 500V		
	C 317	QEHR1VM-476Z	E CAPACITOR	47MF 20% 35V			C 923	QCS32HJ-470Z	C CAPACITOR	47PF 5% 500V		
	C 318	QEHR1VM-476Z	E CAPACITOR	47MF 20% 35V			C 925	QFLC1HJ-473Z	M CAPACITOR	.047MF 5% 50V		
	C 319	QETN1JM-107Z	E CAPACITOR	100MF 20% 63V			C 927	QFLC1HJ-473Z	M CAPACITOR	.047MF 5% 50V		
	C 320	QETN1JM-107Z	E CAPACITOR	100MF 20% 63V			C 929	QETN1HM-476Z	E CAPACITOR	47MF 20% 50V		
	C 321	QCS32HJ-470Z	C CAPACITOR	47PF 5% 500V			CN201	QGF1205C1-14	CONNECTOR			
	C 322	QCS32HJ-470Z	C CAPACITOR	47PF 5% 500V			CN203	QGD2501C1-05Z	SOCKET			
	C 323	QCS32HJ-470Z	C CAPACITOR	47PF 5% 500V			CN241	QGD2501C1-05Z	SOCKET			
	C 324	QCS32HJ-470Z	C CAPACITOR	47PF 5% 500V			CN251	QGA3901F2-03	CONNECTOR			
	C 325	QFLC1HJ-473Z	M CAPACITOR	.047MF 5% 50V			CN291	QGB2510J1-04	CONNECTOR			
	C 326	QFLC1HJ-473Z	M CAPACITOR	.047MF 5% 50V			CN292	QGB2510K1-04	CONNECTOR			
	C 327	QFLC1HJ-473Z	M CAPACITOR	.047MF 5% 50V			CN301	QGB2510K1-14	CONNECTOR			
	C 328	QFLC1HJ-473Z	M CAPACITOR	.047MF 5% 50V			CN302	QGB2510K1-14	CONNECTOR			
	C 501	QETN1HM-475Z	E CAPACITOR	4.7MF 20% 50V			CN492	QGB2510K1-04	CONNECTOR			
	C 503	QETN0JM-477Z	E CAPACITOR	470MF 20% 6.3V			CN501	QGB2510K1-07	CONNECTOR			
	C 504	QCS31HJ-470Z	C CAPACITOR	47PF 5% 50V			CN801	QGB2510K1-14	CONNECTOR			
	C 505	QETN1HM-475Z	E CAPACITOR	4.7MF 20% 50V			CN802	QGB2510K1-14	CONNECTOR			
	C 506	QETN0JM-477Z	E CAPACITOR	470MF 20% 6.3V			CN901	QGB2510K1-14	CONNECTOR			
	C 507	QCS31HJ-470Z	C CAPACITOR	47PF 5% 50V			C1331	QCB1HK-331Y	C CAPACITOR	330PF 10% 50V		
	C 511	QETN1CM-108Z	E CAPACITOR	1000MF 20% 16V			C1332	QCB1HK-331Y	C CAPACITOR	330PF 10% 50V		
	C 512	QCB1HK-223Y	C CAPACITOR	.022MF 10% 50V			△	D 201	10E2-FD	DIODE		
	C 521	QCB1HK-221Y	C CAPACITOR	220PF 10% 50V			△	D 202	1SR35-400A-T5	DIODE		
	C 522	QCZ0202-155Z	ML C CAPACITOR	1.5MF			△	D 203	10E2-FD	DIODE		
	C 801	QEHR1HM-106Z	E CAPACITOR	10MF 20% 50V			△	D 204	1SR35-400A-T5	DIODE		
	C 802	QEHR1HM-106Z	E CAPACITOR	10MF 20% 50V			△	D 206	1SR35-400A-T5	DIODE		
	C 803	QCS31HJ-271Z	C CAPACITOR	270PF 5% 50V			△	D 207	1SR35-400A-T5	DIODE		
	C 804	QCS31HJ-271Z	C CAPACITOR	270PF 5% 50V			△	D 208	1SR35-400A-T5	DIODE		
	C 805	QCS31HJ-221Z	C CAPACITOR	220PF 5% 50V			△	D 209	1SR35-400A-T5	DIODE		
	C 806	QCS31HJ-221Z	C CAPACITOR	220PF 5% 50V				D 210	1SS133-T2	SI DIODE		
	C 807	QCB31HK-152Z	C CAPACITOR	1500PF 10% 50V				D 211	MTZJ6.8C-T2	Z DIODE		
	C 808	QCB31HK-152Z	C CAPACITOR	1500PF 10% 50V				D 212	1SR139-400-T4	DIODE		
	C 809	QETN1EM-107Z	E CAPACITOR	100MF 20% 25V				D 217	MTZJ6.2C-T2	Z DIODE		
	C 810	QETN1EM-107Z	E CAPACITOR	100MF 20% 25V				D 218	1SS133-T2	SI DIODE IM		
	C 811	QCS31HJ-100Z	C CAPACITOR	10PF 5% 50V				D 219	1SR139-400-T4	DIODE		
	C 812	QCS31HJ-100Z	C CAPACITOR	10PF 5% 50V				D 220	1SR139-400-T4	DIODE		

■ Electrical parts list (Power amp board)

Block No. 01

△	Item	Parts number	Parts name	Remarks	Area	△	Item	Parts number	Parts name	Remarks	Area
	D 221	1SS133-T2	SI DIODE				Q 304	2SC2240/L-T	TRANSISTOR		
	D 222	MTZJ12C-T2	Z DIODE				Q 305	KTA1268/GL-T	TRANSISTOR		
	D 223	1SS133-T2	SI DIODE				Q 306	KTA1268/GL-T	TRANSISTOR		
	D 301	1SS133-T2	SI DIODE				Q 307	KTC3200/GL-T	TRANSISTOR		
	D 302	1SS133-T2	SI DIODE				Q 308	KTC3200/GL-T	TRANSISTOR		
	D 303	SLR-342MC-T	LED				Q 309	2SD637/QR/	TRANSISTOR		
	D 304	SLR-342MC-T	LED				Q 310	2SD637/QR/	TRANSISTOR		
	D 305	1SS133-T2	SI DIODE				Q 311	KTC3200/GL-T	TRANSISTOR		
	D 306	1SS133-T2	SI DIODE				Q 312	KTC3200/GL-T	TRANSISTOR		
	D 307	1SS133-T2	SI DIODE				Q 313	KTA1268/GL-T	TRANSISTOR		
	D 308	1SS133-T2	SI DIODE				Q 314	KTA1268/GL-T	TRANSISTOR		
	D 309	1SS133-T2	SI DIODE			△	Q 315	2SD2390/OPY/-F6	TRANSISTOR		
	D 310	1SS133-T2	SI DIODE			△	Q 316	2SD2390/OPY/-F6	TRANSISTOR		
	D 801	1SS133-T2	SI DIODE			△	Q 317	2SB1560/OPY/-F6	TRANSISTOR		
	D 802	1SS133-T2	SI DIODE			△	Q 318	2SB1560/OPY/-F6	TRANSISTOR		
	D 805	1SS133-T2	SI DIODE				Q 319	KTA1268/GL-T	TRANSISTOR		
	D 806	1SS133-T2	SI DIODE				Q 320	KTA1268/GL-T	TRANSISTOR		
	D 807	1SS133-T2	SI DIODE				Q 501	KTA1267/YG-T	TRANSISTOR		
	D 808	1SS133-T2	SI DIODE				Q 502	KTC3199/GL-T	TRANSISTOR		
	D 809	1SS133-T2	SI DIODE				Q 503	KRC101M-T	TRANSISTOR		
	D 810	1SS133-T2	SI DIODE				Q 504	KTA1267/YG-T	TRANSISTOR		
	D 901	1SS133-T2	SI DIODE				Q 505	KTC3199/GL-T	TRANSISTOR		
	D 905	1SS133-T2	SI DIODE				Q 801	2SC2240/L-T	TRANSISTOR		
	D 907	1SS133-T2	SI DIODE				Q 802	2SC2240/L-T	TRANSISTOR		
	D 909	1SS133-T2	SI DIODE				Q 803	2SC2240/L-T	TRANSISTOR		
	EP 1	E409182-001SM	GRAND TERMINAL				Q 804	2SC2240/L-T	TRANSISTOR		
	EP201	QNZ0136-001Z	EARTH PLATE				Q 805	KTA1268/GL-T	TRANSISTOR		
	FC211	QNG0020-001Z	FUSE CLIP				Q 806	KTA1268/GL-T	TRANSISTOR		
	FC212	QNG0020-001Z	FUSE CLIP				Q 809	2SD637/QR/	TRANSISTOR		
	FC221	QNG0020-001Z	FUSE CLIP				Q 810	2SD637/QR/	TRANSISTOR		
	FC222	QNG0020-001Z	FUSE CLIP				Q 811	KTC3200/GL-T	TRANSISTOR		
	FC231	QNG0020-001Z	FUSE CLIP				Q 812	KTC3200/GL-T	TRANSISTOR		
	FC232	QNG0020-001Z	FUSE CLIP				Q 813	KTA1268/GL-T	TRANSISTOR		
	FC241	QNG0020-001Z	FUSE CLIP	RX-6010VBK	UJ		Q 814	KTA1268/GL-T	TRANSISTOR		
	FC241	QNG0020-001Z	FUSE CLIP	RX-6012VSL	US,UY	△	Q 815	2SD2390/OPY/-F6	TRANSISTOR		
	FC242	QNG0020-001Z	FUSE CLIP	RX-6012VSL	US,UY	△	Q 816	2SD2390/OPY/-F6	TRANSISTOR		
	FC242	QNG0020-001Z	FUSE CLIP	RX-6010VBK	UJ	△	Q 817	2SB1560/OPY/-F6	TRANSISTOR		
	FC251	QNG0020-001Z	FUSE CLIP	F205		△	Q 818	2SB1560/OPY/-F6	TRANSISTOR		
	FC252	QNG0020-001Z	FUSE CLIP	F205			Q 819	KTA1268/GL-T	TRANSISTOR		
	FW201	QUM137-13Z4Z4	PARA RIBON WIRE				Q 820	KTA1268/GL-T	TRANSISTOR		
	FW251	QUM133-08Z4Z4	PARA RIBON WIRE				Q 901	2SC2240/L-T	TRANSISTOR		
	HS211	E70945-H40B	HEAT SINK				Q 903	2SC2240/L-T	TRANSISTOR		
	IC501	NJM2246D	IC				Q 905	KTA1268/GL-T	TRANSISTOR		
	J 501	QNN0063-001	PIN JACK				Q 909	2SD637/QR/	TRANSISTOR		
	J 502	QNN0063-001	PIN JACK	VCR(R/P)			Q 911	KTC3200/GL-T	TRANSISTOR		
	J 521	QNS0073-001	JACK				Q 913	KTA1268/GL-T	TRANSISTOR		
	J1331	QNS0022-001	JACK			△	Q 915	2SD2390/OPY/-F6	TRANSISTOR		
	L 301	QQLZ005-R45	INDUCTOR			△	Q 917	2SB1560/OPY/-F6	TRANSISTOR		
	L 302	QQLZ005-R45	INDUCTOR				Q 919	KTA1268/GL-T	TRANSISTOR		
	L 801	QQLZ005-R45	INDUCTOR			△	R 201	QRJ146J-5R6X	UNF C RESISTOR	5.6 5% 1/4W	
	L 802	QQLZ005-R45	INDUCTOR			△	R 203	QRJ146J-3R9X	UNF C RESISTOR	3.9 5% 1/4W	
	L 901	QQLZ005-R45	INDUCTOR			△	R 204	QRJ146J-821X	UNF C RESISTOR	820 5% 1/4W	
	Q 202	KRC105M-T	D TRANSISTOR			△	R 208	QRJ146J-100X	UNF C RESISTOR	10 5% 1/4W	
	Q 203	KTC3203/0Y/-T	TRANSISTOR				R 209	QRE141J-104Y	C RESISTOR	100K 5% 1/4W	
	Q 205	KTC3200/GL/-T	TRANSISTOR			△	R 210	QRJ146J-680X	UNF C RESISTOR	68 5% 1/4W	
	Q 207	KRC105M-T	D TRANSISTOR			△	R 211	QRJ146J-153X	UNF C RESISTOR	15K 5% 1/4W	
	Q 208	KRC105M-T	D TRANSISTOR			△	R 212	QRL012J-332	UNF OMF RESISTOR	3.3K 5% 1/1W	
	Q 209	KRC105M-T	D TRANSISTOR				R 301	QRE141J-222Y	C RESISTOR	2.2K 5% 1/4W	
	Q 210	KRC105M-T	D TRANSISTOR				R 302	QRE141J-222Y	C RESISTOR	2.2K 5% 1/4W	
	Q 211	2SD2395/EF/	TRANSISTOR				R 303	QRE141J-563Y	C RESISTOR	56K 5% 1/4W	
	Q 301	2SC2240/L-T	TRANSISTOR				R 304	QRE141J-563Y	C RESISTOR	56K 5% 1/4W	
	Q 302	2SC2240/L-T	TRANSISTOR				R 305	QRE141J-123Y	C RESISTOR	12K 5% 1/4W	
	Q 303	2SC2240/L-T	TRANSISTOR				R 306	QRE141J-123Y	C RESISTOR	12K 5% 1/4W	

■ Electrical parts list (Power amp board)

Block No. 01

△	Item	Parts number	Parts name	Remarks	Area	△	Item	Parts number	Parts name	Remarks	Area	
	R 307	QRE141J-272Y	C RESISTOR	2.7K 5% 1/4W			R 522	QRE141J-471Y	C RESISTOR	470 5% 1/4W		
	R 308	QRE141J-272Y	C RESISTOR	2.7K 5% 1/4W			R 801	QRE141J-222Y	C RESISTOR	2.2K 5% 1/4W		
	R 309	QRE141J-101Y	C RESISTOR	100 5% 1/4W			R 802	QRE141J-222Y	C RESISTOR	2.2K 5% 1/4W		
	R 310	QRE141J-101Y	C RESISTOR	100 5% 1/4W			R 803	QRE141J-563Y	C RESISTOR	56K 5% 1/4W		
△	R 311	QRJ146J-391X	UNF C RESISTOR	390 5% 1/4W			R 804	QRE141J-563Y	C RESISTOR	56K 5% 1/4W		
△	R 312	QRJ146J-391X	UNF C RESISTOR	390 5% 1/4W			R 805	QRE141J-183Y	C RESISTOR	18K 5% 1/4W		
	R 313	QRE141J-563Y	C RESISTOR	56K 5% 1/4W			R 806	QRE141J-183Y	C RESISTOR	18K 5% 1/4W		
	R 314	QRE141J-563Y	C RESISTOR	56K 5% 1/4W			R 807	QRE141J-302Y	C RESISTOR	3.0K 5% 1/4W		
△	R 315	QRJ146J-331X	UNF C RESISTOR	330 5% 1/4W			R 808	QRE141J-302Y	C RESISTOR	3.0K 5% 1/4W		
△	R 316	QRJ146J-331X	UNF C RESISTOR	330 5% 1/4W			R 809	QRE141J-101Y	C RESISTOR	100 5% 1/4W		
	R 317	QRE141J-473Y	C RESISTOR	47K 5% 1/4W			R 810	QRE141J-101Y	C RESISTOR	100 5% 1/4W		
	R 318	QRE141J-473Y	C RESISTOR	47K 5% 1/4W			△	R 811	QRJ146J-391X	UNF C RESISTOR	390 5% 1/4W	
△	R 319	QRJ146J-331X	UNF C RESISTOR	330 5% 1/4W			△	R 812	QRJ146J-391X	UNF C RESISTOR	390 5% 1/4W	
△	R 320	QRJ146J-331X	UNF C RESISTOR	330 5% 1/4W			R 813	QRE141J-563Y	C RESISTOR	56K 5% 1/4W		
△	R 321	QRJ146J-100X	UNF C RESISTOR	10 5% 1/4W			R 814	QRE141J-563Y	C RESISTOR	56K 5% 1/4W		
△	R 322	QRJ146J-100X	UNF C RESISTOR	10 5% 1/4W			△	R 815	QRJ146J-331X	UNF C RESISTOR	330 5% 1/4W	
△	R 323	QRJ146J-100X	UNF C RESISTOR	10 5% 1/4W			△	R 816	QRJ146J-331X	UNF C RESISTOR	330 5% 1/4W	
△	R 324	QRJ146J-100X	UNF C RESISTOR	10 5% 1/4W			△	R 821	QRJ146J-100X	UNF C RESISTOR	10 5% 1/4W	
	R 325	QRE141J-361Y	C RESISTOR	360 5% 1/4W			△	R 822	QRJ146J-100X	UNF C RESISTOR	10 5% 1/4W	
	R 326	QRE141J-361Y	C RESISTOR	360 5% 1/4W			△	R 823	QRJ146J-100X	UNF C RESISTOR	10 5% 1/4W	
	R 327	QRE141J-471Y	C RESISTOR	470 5% 1/4W			△	R 824	QRJ146J-100X	UNF C RESISTOR	10 5% 1/4W	
	R 328	QRE141J-471Y	C RESISTOR	470 5% 1/4W				R 825	QRE141J-361Y	C RESISTOR	360 5% 1/4W	
	R 329	QRE141J-471Y	C RESISTOR	470 5% 1/4W				R 826	QRE141J-361Y	C RESISTOR	360 5% 1/4W	
	R 330	QRE141J-471Y	C RESISTOR	470 5% 1/4W				R 827	QRE141J-911Y	C RESISTOR	910 5% 1/4W	
△	R 331	QRJ146J-100X	UNF C RESISTOR	10 5% 1/4W				R 828	QRE141J-911Y	C RESISTOR	910 5% 1/4W	
△	R 332	QRJ146J-100X	UNF C RESISTOR	10 5% 1/4W				R 829	QRE141J-221Y	C RESISTOR	220 5% 1/4W	
△	R 333	QRJ146J-100X	UNF C RESISTOR	10 5% 1/4W				R 830	QRE141J-221Y	C RESISTOR	220 5% 1/4W	
△	R 334	QRJ146J-100X	UNF C RESISTOR	10 5% 1/4W			△	R 831	QRJ146J-100X	UNF C RESISTOR	10 5% 1/4W	
	R 335	QRE141J-121Y	C RESISTOR	120 5% 1/4W			△	R 832	QRJ146J-100X	UNF C RESISTOR	10 5% 1/4W	
	R 336	QRE141J-121Y	C RESISTOR	120 5% 1/4W			△	R 833	QRJ146J-100X	UNF C RESISTOR	10 5% 1/4W	
	R 337	QRE141J-121Y	C RESISTOR	120 5% 1/4W			△	R 834	QRJ146J-100X	UNF C RESISTOR	10 5% 1/4W	
	R 338	QRE141J-121Y	C RESISTOR	120 5% 1/4W				R 835	QRE141J-181Y	C RESISTOR	180 5% 1/4W	
	R 339	QRE141J-181Y	C RESISTOR	180 5% 1/4W				R 836	QRE141J-181Y	C RESISTOR	180 5% 1/4W	
	R 340	QRE141J-181Y	C RESISTOR	180 5% 1/4W				R 837	QRE141J-181Y	C RESISTOR	180 5% 1/4W	
	R 341	QRE141J-181Y	C RESISTOR	180 5% 1/4W				R 838	QRE141J-181Y	C RESISTOR	180 5% 1/4W	
	R 342	QRE141J-181Y	C RESISTOR	180 5% 1/4W				R 839	QRE141J-181Y	C RESISTOR	180 5% 1/4W	
△	R 343	QRZ0218-R22	EMIT RESISTOR	1/2W				R 840	QRE141J-181Y	C RESISTOR	180 5% 1/4W	
△	R 344	QRZ0218-R22	EMIT RESISTOR	1/2W				R 841	QRE141J-181Y	C RESISTOR	180 5% 1/4W	
	R 345	QRE141J-102Y	C RESISTOR	1.0K 5% 1/4W				R 842	QRE141J-181Y	C RESISTOR	180 5% 1/4W	
	R 346	QRE141J-102Y	C RESISTOR	1.0K 5% 1/4W			△	R 843	QRZ0218-R22	EMIT RESISTOR	1/2W	
	R 347	QRE141J-153Y	C RESISTOR	15K 5% 1/4W			△	R 844	QRZ0218-R22	EMIT RESISTOR	1/2W	
	R 348	QRE141J-153Y	C RESISTOR	15K 5% 1/4W				R 845	QRE141J-102Y	C RESISTOR	1.0K 5% 1/4W	
	R 349	QRE141J-473Y	C RESISTOR	47K 5% 1/4W				R 846	QRE141J-102Y	C RESISTOR	1.0K 5% 1/4W	
	R 350	QRE141J-473Y	C RESISTOR	47K 5% 1/4W				R 847	QRE141J-183Y	C RESISTOR	18K 5% 1/4W	
△	R 351	QRJ125J-330	UNF C RESISTOR	33 5% 1/2W				R 848	QRE141J-183Y	C RESISTOR	18K 5% 1/4W	
△	R 352	QRJ125J-330	UNF C RESISTOR	33 5% 1/2W				R 849	QRE141J-123Y	C RESISTOR	12K 5% 1/4W	
△	R 353	QRL022J-100	UNF OMF RESISTOR	10 5% 1/2W				R 850	QRE141J-123Y	C RESISTOR	12K 5% 1/4W	
△	R 354	QRL022J-100	UNF OMF RESISTOR	10 5% 1/2W			△	R 851	QRJ125J-330	UNF C RESISTOR	33 5% 1/2W	
	R 501	QRE141J-331Y	C RESISTOR	330 5% 1/4W			△	R 852	QRJ125J-330	UNF C RESISTOR	33 5% 1/2W	
	R 502	QRE141J-750Y	C RESISTOR	75 5% 1/4W			△	R 853	QRL022J-100	UNF OMF RESISTOR	10 5% 1/2W	
	R 505	QRE141J-750Y	C RESISTOR	75 5% 1/4W			△	R 854	QRL022J-100	UNF OMF RESISTOR	10 5% 1/2W	
	R 506	QRE141J-473Y	C RESISTOR	47K 5% 1/4W				R 855	QRE141J-332Y	C RESISTOR	3.3K 5% 1/4W	
	R 507	QRE141J-331Y	C RESISTOR	330 5% 1/4W				R 856	QRE141J-332Y	C RESISTOR	3.3K 5% 1/4W	
	R 508	QRE141J-750Y	C RESISTOR	75 5% 1/4W				R 857	QRE141J-332Y	C RESISTOR	3.3K 5% 1/4W	
	R 509	QRE141J-750Y	C RESISTOR	75 5% 1/4W				R 858	QRE141J-332Y	C RESISTOR	3.3K 5% 1/4W	
	R 510	QRE141J-473Y	C RESISTOR	47K 5% 1/4W				R 859	QRE141J-332Y	C RESISTOR	3.3K 5% 1/4W	
	R 511	QRE141J-151Y	C RESISTOR	150 5% 1/4W				R 860	QRE141J-332Y	C RESISTOR	3.3K 5% 1/4W	
	R 512	QRE141J-271Y	C RESISTOR	270 5% 1/4W				R 861	QRE141J-332Y	C RESISTOR	3.3K 5% 1/4W	
	R 513	QRE141J-152Y	C RESISTOR	1.5K 5% 1/4W				R 862	QRE141J-332Y	C RESISTOR	3.3K 5% 1/4W	
	R 514	QRE141J-151Y	C RESISTOR	150 5% 1/4W				R 901	QRE141J-222Y	C RESISTOR	2.2K 5% 1/4W	
	R 515	QRE141J-271Y	C RESISTOR	270 5% 1/4W				R 903	QRE141J-563Y	C RESISTOR	56K 5% 1/4W	
	R 516	QRE141J-152Y	C RESISTOR	1.5K 5% 1/4W				R 905	QRE141J-183Y	C RESISTOR	18K 5% 1/4W	
	R 521	QRE141J-221Y	C RESISTOR	220 5% 1/4W				R 907	QRE141J-302Y	C RESISTOR	3.0K 5% 1/4W	

■ Electrical parts list (Power amp board)

Block No. 01

△	Item	Parts number	Parts name	Remarks	Area
	R 909	QRE141J-101Y	C RESISTOR	100 5% 1/4W	
△	R 911	QRJ146J-301X	UNF C RESISTOR	300 5% 1/4W	
	R 913	QRE141J-563Y	C RESISTOR	56K 5% 1/4W	
△	R 915	QRJ146J-331X	UNF C RESISTOR	330 5% 1/4W	
△	R 921	QRJ146J-100X	UNF C RESISTOR	10 5% 1/4W	
△	R 923	QRJ146J-100X	UNF C RESISTOR	10 5% 1/4W	
	R 925	QRE141J-361Y	C RESISTOR	360 5% 1/4W	
	R 927	QRE141J-911Y	C RESISTOR	910 5% 1/4W	
	R 929	QRE141J-221Y	C RESISTOR	220 5% 1/4W	
△	R 931	QRJ146J-100X	UNF C RESISTOR	10 5% 1/4W	
△	R 933	QRJ146J-100X	UNF C RESISTOR	10 5% 1/4W	
	R 935	QRE141J-181Y	C RESISTOR	180 5% 1/4W	
	R 937	QRE141J-181Y	C RESISTOR	180 5% 1/4W	
	R 939	QRE141J-181Y	C RESISTOR	180 5% 1/4W	
	R 941	QRE141J-181Y	C RESISTOR	180 5% 1/4W	
△	R 943	QRZ0218-R22	EMIT RESISTOR	1/2W	
	R 945	QRE141J-102Y	C RESISTOR	1.0K 5% 1/4W	
	R 947	QRE141J-183Y	C RESISTOR	18K 5% 1/4W	
	R 949	QRE141J-473Y	C RESISTOR	47K 5% 1/4W	
△	R 951	QRJ125J-330	UNF C RESISTOR	33 5% 1/2W	
△	R 953	QRL022J-100	UNF OMF RESISTO	10 5% 1/2W	
	R 955	QRE141J-332Y	C RESISTOR	3.3K 5% 1/4W	
	R 957	QRE141J-332Y	C RESISTOR	3.3K 5% 1/4W	
	R 959	QRE141J-332Y	C RESISTOR	3.3K 5% 1/4W	
	R 961	QRE141J-332Y	C RESISTOR	3.3K 5% 1/4W	
△	RY202	QSK0098-001	RELAY		
△	RY203	QSK0109-001	RELAY		
△	R1331	QRL022J-471	UNF OMF RESISTO	470 5% 1/2W	
△	R1332	QRL022J-471	UNF OMF RESISTO	470 5% 1/2W	
△	T 202	QQT0281-004	POWER TRANSF		
	TA201	QNZ0079-001Z	TAB		
	TA202	QNZ0079-001Z	TAB		
△	TH301	QAD0012-202	THERMISTOR		
△	TH302	QAD0012-202	THERMISTOR		
△	TH801	QAD0012-202	THERMISTOR		
△	TH802	QAD0012-202	THERMISTOR		
△	TH901	QAD0012-202	THERMISTOR		
	VR301	QVP0008-102Z	SEMI V RESISTOR		
	VR302	QVP0008-102Z	SEMI V RESISTOR		
△	VS201	QSW0812-001	VOLTAGE SWITCH	RX-6010VBK	UJ
△	VS201	QSW0812-001	VOLTAGE SWITCH	RX-6012VSL	US,UY

■ Electrical parts list (Main board)

Block No. 02

△	Item	Parts number	Parts name	Remarks	Area	△	Item	Parts number	Parts name	Remarks	Area
	C 419	QCBB1HK-223Y	C CAPACITOR	.022MF 10% 50V			C1373	QFLC1HJ-223Z	M CAPACITOR	.022MF 5% 50V	
	C 420	QCBB1HK-223Y	C CAPACITOR	.022MF 10% 50V			C1374	QCS31HJ-221Z	C CAPACITOR	220PF 5% 50V	
	C 421	QCBB1HK-331Y	C CAPACITOR	330PF 10% 50V			C1375	QCS31HJ-221Z	C CAPACITOR	220PF 5% 50V	
	C 422	QCBB1HK-331Y	C CAPACITOR	330PF 10% 50V			C1376	QCBB1HK-221Y	C CAPACITOR	220PF 10% 50V	
	C 423	QCBB1HK-331Y	C CAPACITOR	330PF 10% 50V		△	D1301	30DF2-FC	DIODE		
	C 424	QCBB1HK-331Y	C CAPACITOR	330PF 10% 50V		△	D1302	30DF2-FC	DIODE		
	C 425	QCBB1HK-331Y	C CAPACITOR	330PF 10% 50V		△	D1303	30DF2-FC	DIODE		
	C 426	QCBB1HK-331Y	C CAPACITOR	330PF 10% 50V		△	D1304	30DF2-FC	DIODE		
	C 427	QCBB1HK-221Y	C CAPACITOR	220PF 10% 50V			D1305	MTZJ22C-T2	Z DIODE		
	C 428	QCBB1HK-221Y	C CAPACITOR	220PF 10% 50V			D1306	MTZJ30C-T2	Z DIODE		
	C 429	QCBB1HK-331Y	C CAPACITOR	330PF 10% 50V			D1307	1SS133-T2	SI DIODE		
	C 430	QCBB1HK-331Y	C CAPACITOR	330PF 10% 50V			D1308	1SS133-T2	SI DIODE		
	C 431	QCBB1HK-331Y	C CAPACITOR	330PF 10% 50V			D1309	MTZJ20C-T2	Z DIODE		
	C 432	QCBB1HK-331Y	C CAPACITOR	330PF 10% 50V			D1352	1SS133-T2	SI DIODE		
	C 433	QCBB1HK-221Y	C CAPACITOR	220PF 10% 50V			D1353	1SS133-T2	SI DIODE		
	C 434	QCBB1HK-221Y	C CAPACITOR	220PF 10% 50V			D1354	1SS133-T2	SI DIODE		
	C 435	QCBB1HK-331Y	C CAPACITOR	330PF 10% 50V			D1355	1SS133-T2	SI DIODE		
	C 436	QCBB1HK-331Y	C CAPACITOR	330PF 10% 50V			D1356	MTZJ5.1C-T2	Z DIODE		
	C 440	QCBB1HK-221Y	C CAPACITOR	220PF 10% 50V			D1357	1SS133-T2	SI DIODE		
	C 441	QETN1HM-475Z	E CAPACITOR	4.7MF 20% 50V			D1358	1SS133-T2	SI DIODE		
	C 442	QETN1HM-475Z	E CAPACITOR	4.7MF 20% 50V			D1359	1SS133-T2	SI DIODE		
	C 443	QETN1HM-475Z	E CAPACITOR	4.7MF 20% 50V			D1360	1SS133-T2	SI DIODE		
	C 444	QETN1HM-475Z	E CAPACITOR	4.7MF 20% 50V			EP301	QNZ0136-001Z	EARTH PLATE		
	C 445	QCBB1HK-223Y	C CAPACITOR	.022MF 10% 50V			FW301	QUM135-25Z4Z4	PARA RIBON WIRE		
	C 446	QCBB1HK-223Y	C CAPACITOR	.022MF 10% 50V			FW302	QUM136-25Z4Z4	PARA RIBON WIRE		
	CN311	QGB2510J1-14	CONNECTOR				FW303	QUM135-28DGZ4	PARA RIBON WIRE		
	CN312	QGB2510J1-14	CONNECTOR				FW341	QUM135-20DGZ4	SOCKET		
	CN321	QGB2510J1-14	CONNECTOR				IC402	TC9164AN	IC		
	CN331	QGB2510J1-14	CONNECTOR				IC403	BA15218N	IC		
	CN332	QGB2510J1-14	CONNECTOR				J 402	QNN0168-001	PIN JACK		
	CN351	QJK012-032403	SKT WIRE ASSY				J 403	QNN0168-001	PIN JACK		
	CN371	QJP001-031201	SHI CR C-B WIRE				L1351	QQLZ005-R45	INDUCTOR		
	CN372	QJP002-021201	SHI CR C-B WIRE				L1352	QQLZ005-R45	INDUCTOR		
	CN373	QJP001-031201	SHI CR C-B WIRE				L1353	QQLZ005-R45	INDUCTOR		
	CN401	QGB2510K1-14	CONNECTOR				L1354	QQLZ005-R45	INDUCTOR		
	C1301	QFZ9076-104Z	MM CAPACITOR	.10MF			L1355	QQLZ005-R45	INDUCTOR		
	C1302	QCE22HP-103	C CAPACITOR	.010MF +100:-0%		△	Q1301	KTA1046/Y/	TRANSISTOR		
	C1303	QCE22HP-103	C CAPACITOR	.010MF +100:-0%			Q1302	KTC3200/GL/-T	TRANSISTOR		
	C1304	QEZ0341-688	E CAPACITER	6800MF			Q1303	KTA1268/GL/-T	TRANSISTOR		
	C1305	QEZ0341-688	E CAPACITER	6800MF			Q1304	KTC3199/GL/-T	TRANSISTOR		
	C1306	QETN1EM-476Z	E CAPACITOR	47MF 20% 25V		△	Q1305	2SD2395/EF/	TRANSISTOR		
	C1308	QETN1HM-476Z	E CAPACITOR	47MF 20% 50V			Q1306	KTA1023/OY/-T	TRANSISTOR		
	C1309	QETN1HM-106Z	E CAPACITOR	10MF 20% 50V			Q1307	KTC3200/GL/-T	TRANSISTOR		
	C1310	QETN1CM-476Z	E CAPACITOR	47MF 20% 16V			Q1351	KRC109M-T	D TRANSISTOR		
	C1311	QEK1HM-226Z	E CAPACITOR	22MF 20% 50V			Q1352	KRC109M-T	D TRANSISTOR		
	C1351	QETN1HM-475Z	E CAPACITOR	4.7MF 20% 50V			Q1353	KRC109M-T	D TRANSISTOR		
	C1352	QETN1HM-475Z	E CAPACITOR	4.7MF 20% 50V			Q1354	KRC109M-T	D TRANSISTOR		
	C1353	QEK1HM-475Z	E CAPACITOR	4.7MF 20% 50V			Q1355	KRC109M-T	D TRANSISTOR		
	C1354	QETN1HM-475Z	E CAPACITOR	4.7MF 20% 50V			Q1356	KRC109M-T	D TRANSISTOR		
	C1359	QFLC1HJ-223Z	M CAPACITOR	.022MF 5% 50V			Q1357	KRC109M-T	D TRANSISTOR		
	C1360	QFLC1HJ-223Z	M CAPACITOR	.022MF 5% 50V			Q1358	KRC109M-T	D TRANSISTOR		
	C1361	QFLC1HJ-223Z	M CAPACITOR	.022MF 5% 50V			R 421	QRE141J-471Y	C RESISTOR	470 5% 1/4W	
	C1362	QCS31HJ-221Z	C CAPACITOR	220PF 5% 50V			R 422	QRE141J-471Y	C RESISTOR	470 5% 1/4W	
	C1363	QFLC1HJ-223Z	M CAPACITOR	.022MF 5% 50V			R 423	QRE141J-471Y	C RESISTOR	470 5% 1/4W	
	C1364	QCS31HJ-221Z	C CAPACITOR	220PF 5% 50V			R 424	QRE141J-471Y	C RESISTOR	470 5% 1/4W	
	C1365	QFLC1HJ-473Z	M CAPACITOR	.047MF 5% 50V			R 425	QRE141J-471Y	C RESISTOR	470 5% 1/4W	
	C1366	QCS31HJ-221Z	C CAPACITOR	220PF 5% 50V			R 426	QRE141J-471Y	C RESISTOR	470 5% 1/4W	
	C1367	QCBB1HK-221Y	C CAPACITOR	220PF 10% 50V			R 429	QRE141J-471Y	C RESISTOR	470 5% 1/4W	
	C1368	QFLC1HJ-102Z	M CAPACITOR	1000PF 5% 50V			R 430	QRE141J-471Y	C RESISTOR	470 5% 1/4W	
	C1369	QFLC1HJ-223Z	M CAPACITOR	.022MF 5% 50V			R 431	QRE141J-471Y	C RESISTOR	470 5% 1/4W	
	C1370	QCS31HJ-221Z	C CAPACITOR	220PF 5% 50V			R 432	QRE141J-471Y	C RESISTOR	470 5% 1/4W	
	C1371	QCBB1HK-221Y	C CAPACITOR	220PF 10% 50V			R 435	QRE141J-471Y	C RESISTOR	470 5% 1/4W	
	C1372	QCS31HJ-221Z	C CAPACITOR	220PF 5% 50V			R 436	QRE141J-471Y	C RESISTOR	470 5% 1/4W	

■ Electrical parts list (Main board)

Block No. 02

△	Item	Parts number	Parts name	Remarks	Area
	R 440	QRE141J-102Y	C RESISTOR	1.0K 5% 1/4W	
	R 441	QRE141J-104Y	C RESISTOR	100K 5% 1/4W	
	R 442	QRE141J-104Y	C RESISTOR	100K 5% 1/4W	
	R 443	QRE141J-104Y	C RESISTOR	100K 5% 1/4W	
	R 444	QRE141J-104Y	C RESISTOR	100K 5% 1/4W	
	R 445	QRE141J-104Y	C RESISTOR	100K 5% 1/4W	
	R 446	QRE141J-104Y	C RESISTOR	100K 5% 1/4W	
△	R 449	QRJ146J-271X	UNF C RESISTOR	270 5% 1/4W	
△	R 450	QRJ146J-271X	UNF C RESISTOR	270 5% 1/4W	
△	RY302	QSK0109-001	RELAY		
△	RY303	QSK0109-001	RELAY		
△	RY304	QSK0109-001	RELAY		
△	R1301	QRL022J-562	UNF OMF RESISTOR	5.6K 5% 1/2W	
△	R1302	QRZ9005-100X	F RESISTOR	10 1/0W	
△	R1303	QRJ146J-562X	UNF C RESISTOR	5.6K 5% 1/4W	
	R1304	QRE141J-104Y	C RESISTOR	100K 5% 1/4W	
	R1305	QRE141J-104Y	C RESISTOR	100K 5% 1/4W	
	R1306	QRE141J-823Y	C RESISTOR	82K 5% 1/4W	
	R1307	QRE141J-104Y	C RESISTOR	100K 5% 1/4W	
	R1308	QRE141J-104Y	C RESISTOR	100K 5% 1/4W	
	R1309	QRE141J-103Y	C RESISTOR	10K 5% 1/4W	
	R1310	QRE141J-103Y	C RESISTOR	10K 5% 1/4W	
	R1311	QRE141J-104Y	C RESISTOR	100K 5% 1/4W	
	R1312	QRE141J-104Y	C RESISTOR	100K 5% 1/4W	
△	R1313	QRZ9005-100X	F RESISTOR	10 1/0W	
△	R1314	QRJ146J-103X	UNF C RESISTOR	10K 5% 1/4W	
△	R1315	QRJ146J-2R2X	UNF C RESISTOR	2.2 5% 1/4W	
△	R1316	QRJ146J-102X	UNF C RESISTOR	1.0K 5% 1/4W	
△	R1317	QRJ146J-223X	UNF C RESISTOR	22K 5% 1/4W	
	R1318	QRE141J-223Y	C RESISTOR	22K 5% 1/4W	
	R1319	QRE141J-473Y	C RESISTOR	47K 5% 1/4W	
△	R1352	QRJ146J-680X	UNF C RESISTOR	68 5% 1/4W	
△	R1353	QRJ146J-680X	UNF C RESISTOR	68 5% 1/4W	
△	R1354	QRJ146J-680X	UNF C RESISTOR	68 5% 1/4W	
△	R1355	QRJ146J-392X	UNF C RESISTOR	3.9K 5% 1/4W	
	R1356	QRE141J-472Y	C RESISTOR	4.7K 5% 1/4W	
	R1357	QRE141J-223Y	C RESISTOR	22K 5% 1/4W	
	R1358	QRE141J-682Y	C RESISTOR	6.8K 5% 1/4W	
	R1359	QRE141J-472Y	C RESISTOR	4.7K 5% 1/4W	
	R1360	QRE141J-472Y	C RESISTOR	4.7K 5% 1/4W	
	R1361	QRE141J-472Y	C RESISTOR	4.7K 5% 1/4W	
	R1362	QRE141J-472Y	C RESISTOR	4.7K 5% 1/4W	
	R1363	QRE141J-472Y	C RESISTOR	4.7K 5% 1/4W	
	R1364	QRE141J-223Y	C RESISTOR	22K 5% 1/4W	
	R1365	QRE141J-682Y	C RESISTOR	6.8K 5% 1/4W	
	R1366	QRE141J-223Y	C RESISTOR	22K 5% 1/4W	
	R1367	QRE141J-682Y	C RESISTOR	6.8K 5% 1/4W	
△	R1370	QRJ146J-2R7X	UNF C RESISTOR	2.7 5% 1/4W	
△	R1371	QRJ146J-2R7X	UNF C RESISTOR	2.7 5% 1/4W	
△	R1372	QRJ146J-2R7X	UNF C RESISTOR	2.7 5% 1/4W	
△	R1373	QRJ146J-2R7X	UNF C RESISTOR	2.7 5% 1/4W	
△	R1374	QRJ146J-2R7X	UNF C RESISTOR	2.7 5% 1/4W	
	ST304	QNB0103-002	SPK TERMINAL		
	ST305	QNB0001-002	SPK TERMINAL		

■ Electrical parts list (System control & Audio board) Block No. 03

△	Item	Parts number	Parts name	Remarks	Area
	BK701	LV42093-001A	FL HOLDER(L)		
	BK702	LV42092-001A	FL HOLDER(R)		
	C 451	NCB31HK-331X	C CAPACITOR		
	C 452	NCB31HK-331X	C CAPACITOR		
	C 459	QFLC1HJ-104Z	M CAPACITOR	.10MF 5% 50V	
	C 460	QCZ0202-155Z	ML C CAPA	1.5MF	
	C 701	QETN0JM-107Z	E CAPACITOR	100MF 20% 6.3V	
	C 702	QCZ0202-155Z	ML C CAPACITOR	1.5MF	
	C 703	QETN1HM-225Z	E CAPACITOR	2.2MF 20% 50V	
	C 704	NCB31CK-223X	C CAPACITOR		
	C 705	QETN0JM-107Z	E CAPACITOR	100MF 20% 6.3V	
	C 706	NCB21HK-331X	C CAPACITOR		
	C 707	QETN1HM-475Z	E CAPACITOR	4.7MF 20% 50V	
	C 708	QETN1HM-475Z	E CAPACITOR	4.7MF 20% 50V	
	C 709	QETN1HM-475Z	E CAPACITOR	4.7MF 20% 50V	
	C 713	NCB21HK-103X	C CAPACITOR		
	C 714	NCB21HK-103X	C CAPACITOR		
	C 715	NCB21HK-103X	C CAPACITOR		
	C 716	NCB21HK-103X	C CAPACITOR		
	C 717	NCB21HK-103X	C CAPACITOR		
	C 718	NCB21HK-103X	C CAPACITOR		
	C 719	NCB21HK-103X	C CAPACITOR		
	C 720	NCB31CK-104X	C CAPACITOR		
	C 721	NCB31CK-104X	C CAPACITOR		
	C 722	QCZ0202-155Z	ML C CAPACITOR	1.5MF	
	C 730	NCB31CK-104X	C CAPACITOR		
	CN402	QGF1205C1-25	CONNECTOR		
	CN411	QGB2501J1-12	CONNECTOR		
	CN421	QGB2510J1-14	CONNECTOR		
	CN431	QGB2510J1-11	CONNECTOR		
	CN441	QGB2510J1-07	CONNECTOR		
	CN451	QGB2510K1-11	CONNECTOR		
	CN471	QGA2501C1-03	3P CONNECTOR		
	CN472	QGA2501C1-02	2P CONNECTOR		
	CN473	QGA2501C1-03	3P CONNECTOR		
	CN481	QGB2510J1-20	CONNECTOR		
	CN491	QGB2510J1-04	CONNECTOR		
	CN701	QGF1205F1-14	CONNECTOR		
	CN702	QGF1205F1-25	CONNECTOR		
	CN704	WJS0020-001A	SKT WIRE ASS'Y		
	CN714	QGA2001C1-03	3P PLUG ASSY		
	C1401	QETN1HM-476Z	E CAPACITOR	47MF 20% 50V	
	C1402	QETN1EM-107Z	E CAPACITOR	100MF 20% 25V	
	C1403	QETN1EM-107Z	E CAPACITOR	100MF 20% 25V	
	C1404	QETN1EM-107Z	E CAPACITOR	100MF 20% 25V	
	C1405	QETN1EM-107Z	E CAPACITOR	100MF 20% 25V	
	C1406	QETN1EM-107Z	E CAPACITOR	100MF 20% 25V	
	C1407	QCF31HZ-223Z	C CAPACITOR	.022MF +80~-20%	
	C1408	QETN1EM-476Z	E CAPACITOR	47MF 20% 25V	
	C1409	QETN1EM-476Z	E CAPACITOR	47MF 20% 25V	
	C1410	NCB31CK-223X	C CAPACITOR		
	C1411	NCB31CK-223X	C CAPACITOR		
	C1420	QEKC1HM-475Z	E CAPACITOR	4.7MF 20% 50V	
	C1421	QEKC1HM-475Z	E CAPACITOR	4.7MF 20% 50V	
	C1422	QETN1HM-475Z	E CAPACITOR	4.7MF 20% 50V	
	C1423	QEKC1HM-475Z	E CAPACITOR	4.7MF 20% 50V	
	C1424	QEKC1HM-475Z	E CAPACITOR	4.7MF 20% 50V	
	C1425	QETN1AM-107Z	E CAPACITOR	100MF 20% 10V	
	C1426	NCB31CK-223X	C CAPACITOR		
	C1427	QFVF1HJ-334Z	MF CAPACITOR	.33MF 5% 50V	
	C1428	QFLC1HJ-153Z	M CAPACITOR	.015MF 5% 50V	
	C1429	QCB31HK-822Z	C CAPACITOR	8200PF 10% 50V	
	C1430	QETN1HM-475Z	E CAPACITOR	4.7MF 20% 50V	
△	C1431	QETN1HM-475Z	E CAPACITOR	4.7MF 20% 50V	
	C1432	NCB31CK-223X	C CAPACITOR		
	C1433	QFVF1HJ-334Z	MF CAPACITOR	.33MF 5% 50V	
	C1434	QFLC1HJ-153Z	M CAPACITOR	.015MF 5% 50V	
	C1435	QCB31HK-822Z	C CAPACITOR	8200PF 10% 50V	
	C1436	NCB31CK-223X	C CAPACITOR		
	C1437	QCZ0202-155Z	ML C CAPACITOR	1.5MF	
	C1438	QETN0JM-477Z	E CAPACITOR	470MF 20% 6.3V	
	C1439	QFLC1HJ-562Z	M CAPACITOR	5600PF 5% 50V	
	C1440	QFLC1HJ-562Z	M CAPACITOR	5600PF 5% 50V	
	C1444	NCB31CK-223X	C CAPACITOR		
	C1445	NCB31CK-223X	C CAPACITOR		
	C1446	NCB31HK-221X	C CAPACITOR		
	C1447	QETN1HM-475Z	E CAPACITOR	4.7MF 20% 50V	
	C1453	QETN1HM-475Z	E CAPACITOR	4.7MF 20% 50V	
	C1459	QETN1HM-475Z	E CAPACITOR	4.7MF 20% 50V	
	C1460	NCB31CK-223X	C CAPACITOR		
	C1461	NCB31CK-223X	C CAPACITOR		
	D 701	1SS355-X	DIODE		
	D 702	1SS355-X	DIODE		
	D 719	SLR-342VC-T	LED		
	DI701	QLF0082-001	FL TUBE		
	D1401	MTZJ13C-T2	Z DIODE		
	D1402	MTZJ6.2C-T2	Z DIODE		
	D1403	MTZJ5.6C-T2	Z DIODE		
	D1404	MTZJ5.6C-T2	Z DIODE		
	D1405	MTZJ13C-T2	Z DIODE		
	D1406	MTZJ10C-T2	Z DIODE		
	D1407	MTZJ7.5C-T2	Z DIODE		
	D1408	MTZJ7.5C-T2	Z DIODE		
	D1409	1SS355-X	DIODE		
	D1410	1SS355-X	DIODE		
	D1411	1SS355-X	DIODE		
	D1412	1SS355-X	DIODE		
	D1413	1SR35-400A-T5	DIODE		
	EP401	QNZ0136-001Z	EARTH PLATE		
	FL401	QQR0590-001	FILTER		
	FL402	QQR0590-001	FILTER		
	HS401	E70306-001	HEAT SINK		
	HS402	E70306-001	HEAT SINK		
	HS403	E70306-001	HEAT SINK		
	HS404	E70306-001	HEAT SINK		
	HS405	E70306-001	HEAT SINK		
	HS434	E70306-001	HEAT SINK		
	HS435	E70306-001	HEAT SINK		
	IC423	TC9162AF-X	IC		
	IC427	BA15218F-XE	IC		
	IC428	M62446FP-X	IC		
	IC701	MN101C35DHK1	IC		
	IC702	IC-PST9139-T	IC		
	IC703	GP1U281X	IC		
	J 404	QNN0389-001	PIN JACK		DVD-FL/FR
	J 406	QNN0060-001	PIN JACK		SW OUT
	JS701	QSW0898-001	JOG VOLUME		
	Q 701	DTC114YKA-X	CHIP D TRANSIST		
	Q 702	DTC114TKA-X	TRANSISTOR		
	Q 703	DTC144WKA-X	TRANSISTOR		
	Q 704	DTC114YKA-X	CHIP D TRANSIST		
	Q 707	DTC114YKA-X	CHIP D TRANSIST		
	Q 708	DTC114YKA-X	CHIP D TRANSIST		
	Q 709	DTC114YKA-X	CHIP D TRANSIST		
	Q 711	DTA144EKA-X	TRANSISTOR		
△	Q1401	KTA1046/Y/	TRANSISTOR		

■ Electrical parts list (System control & Audio board) Block No. 03

△	Item	Parts number	Parts name	Remarks	Area
△	Q1402	2SD2395/EF/	TRANSISTOR		
△	Q1403	2SD2395/EF/	TRANSISTOR		
△	Q1404	2SD2395/EF/	TRANSISTOR		
△	Q1405	2SD2395/EF/	TRANSISTOR		
△	Q1406	KTC3203/OY/-T	TRANSISTOR		
△	Q1407	KTC3203/OY/-T	TRANSISTOR		
△	Q1408	KTA1271/OY/-T	TRANSISTOR		
	Q1413	2SC3576-JVC-T	TRANSISTOR		
	Q1414	2SC3576-JVC-T	TRANSISTOR		
	Q1417	2SC3576-JVC-T	TRANSISTOR		
	Q1418	2SC3576-JVC-T	TRANSISTOR		
	Q1419	2SC3576-JVC-T	TRANSISTOR		
	Q1420	KRA104M-T	D TRANSISTOR		
	Q1421	2SC3576-JVC-T	TRANSISTOR		
	Q1422	2SC3576-JVC-T	TRANSISTOR		
	Q1423	KRA104M-T	D TRANSISTOR		
	Q1424	KRA104M-T	D TRANSISTOR		
	Q1425	2SC3576-JVC-T	TRANSISTOR		
	Q1426	2SC3576-JVC-T	TRANSISTOR		
	Q1431	KRC104M-T	D TRANSISTOR		
	Q1432	KRC104M-T	D TRANSISTOR		
	Q1433	KRC104M-T	D TRANSISOTR		
△	Q1434	2SD2395/EF/	TRANSISTOR		
△	Q1435	2SD2395/EF/	TRANSISTOR		
	R 451	NRSA63J-471X	MG RESISTOR		
	R 452	NRSA63J-471X	MG RESISTOR		
	R 475	NRSA63J-203X	MG RESISTOR		
	R 476	NRSA63J-273X	MG RESISTOR		
	R 477	QRZ9006-4R7X	F RESISTOR	4.7 1/0W	
	R 478	QRJ146J-2R2X	UNF C RESISTOR	2.2 5% 1/4W	
	R 479	QRJ146J-2R2X	UNF C RESISTOR	2.2 5% 1/4W	
	R 480	NRSA63J-153X	MG RESISTOR		
	R 483	NRSA63J-102X	MG RESISTOR		
	R 484	NRSA63J-104X	MG RESISTOR		
	R 485	NRSA63J-102X	MG RESISTOR		
	R 486	NRSA63J-104X	MG RESISTOR		
	R 487	NRSA63J-102X	MG RESISTOR		
	R 488	NRSA63J-104X	MG RESISTOR		
	R 489	NRSA63J-562X	MG RESISTOR		
	R 490	NRSA63J-562X	MG RESISTOR		
	R 491	NRSA63J-153X	MG RESISTOR		
	R 492	NRSA63J-273X	MG RESISTOR		
	R 493	NRSA63J-273X	MG RESISTOR		
	R 494	NRSA63J-273X	MG RESISTOR		
	R 495	NRSA63J-273X	MG RESISTOR		
	R 496	NRSA63J-273X	MG RESISTOR		
	R 497	NRSA63J-273X	MG RESISTOR		
	R 498	NRSA63J-273X	MG RESISTOR		
	R 499	NRSA63J-273X	MG RESISTOR		
	R 701	NRSA63J-472X	MG RESISTOR		
	R 702	NRSA63J-223X	MG RESISTOR		
	R 703	NRSA63J-103X	MG RESISTOR		
	R 704	NRSA63J-471X	MG RESISTOR		
	R 705	NRSA63J-103X	MG RESISTOR		
	R 706	NRSA63J-103X	MG RESISTOR		
	R 707	NRSA63J-103X	MG RESISTOR		
	R 708	NRSA63J-103X	MG RESISTOR		
	R 709	NRSA63J-103X	MG RESISTOR		
	R 710	NRSA63J-103X	MG RESISTOR		
	R 711	NRSA63J-104X	MG RESISTOR		
	R 712	NRSA63J-103X	MG RESISTOR		
	R 713	NRSA63J-103X	MG RESISTOR		
	R 714	NRSA63J-103X	MG RESISTOR		

△	Item	Parts number	Parts name	Remarks	Area
	R 715	NRSA63J-103X	MG RESISTOR		
	R 716	NRSA63J-103X	MG RESISTOR		
	R 717	NRSA63J-103X	MG RESISTOR		
	R 718	NRSA63J-103X	MG RESISTOR		
	R 719	NRSA63J-221X	MG RESISTOR		
	R 720	NRSA63J-222X	MG RESISTOR		
	R 721	NRSA63J-103X	MG RESISTOR		
	R 722	NRSA63J-102X	MG RESISTOR		
	R 723	NRSA63J-102X	MG RESISTOR		
	R 724	NRSA63J-122X	MG RESISTOR		
	R 725	NRSA63J-152X	MG RESISTOR		
	R 726	NRSA63J-222X	MG RESISTOR		
	R 727	NRSA63J-272X	MG RESISTOR		
	R 728	NRSA63J-103X	MG RESISTOR		
	R 729	NRSA63J-102X	MG RESISTOR		
	R 730	NRSA63J-102X	MG RESISTOR		
	R 731	NRSA63J-122X	MG RESISTOR		
	R 732	NRSA63J-152X	MG RESISTOR		
	R 733	NRSA63J-222X	MG RESISTOR		
	R 734	NRSA63J-272X	MG RESISTOR		
	R 736	NRSA63J-103X	MG RESISTOR		
	R 737	NRSA63J-102X	MG RESISTOR		
	R 738	NRSA63J-102X	MG RESISTOR		
	R 739	NRSA63J-122X	MG RESISTOR		
	R 740	NRSA63J-152X	MG RESISTOR		
	R 741	NRSA63J-222X	MG RESISTOR		
	R 742	NRSA63J-272X	MG RESISTOR		
	R 743	NRSA63J-103X	MG RESISTOR		
	R 744	NRSA63J-102X	MG RESISTOR		
	R 745	NRSA63J-102X	MG RESISTOR		
	R 746	NRSA63J-122X	MG RESISTOR		
	R 747	NRSA63J-152X	MG RESISTOR		
	R 748	NRSA63J-222X	MG RESISTOR		
	R 749	NRSA63J-272X	MG RESISTOR		
	R 750	NRSA63J-103X	MG RESISTOR		
	R 757	NRSA63J-103X	MG RESISTOR		
	R 758	NRSA63J-103X	MG RESISTOR		
	R 759	NRSA63J-103X	MG RESISTOR		
	R 760	NRSA63J-103X	MG RESISTOR		
	R 761	NRSA63J-103X	MG RESISTOR		
	R 762	NRSA63J-102X	MG RESISTOR		
	R 763	NRSA63J-102X	MG RESISTOR		
	R 764	NRSA63J-122X	MG RESISTOR		
	R 765	NRSA63J-152X	MG RESISTOR		
	R 766	NRSA63J-222X	MG RESISTOR		
	R 767	NRSA63J-272X	MG RESISTOR		
	R 768	NRSA63J-103X	MG RESISTOR		
	R 769	NRSA63J-102X	MG RESISTOR		
	R 772	NRSA63J-392X	MG RESISTOR		
	R 773	NRSA63J-392X	MG RESISTOR		
	R 775	NRSA63J-103X	MG RESISTOR		
	R 783	NRSA63J-221X	MG RESISTOR		
	R 784	NRSA63J-221X	MG RESISTOR		
	R 785	NRSA63J-221X	MG RESISTOR		
	R 786	NRSA63J-221X	MG RESISTOR		
	R 787	NRSA63J-221X	MG RESISTOR		
	R 788	NRSA63J-221X	MG RESISTOR		
	R 789	NRSA63J-221X	MG RESISTOR		
	R 790	NRSA63J-221X	MG RESISTOR		
	R 791	NRSA63J-221X	MG RESISTOR		
	R 792	NRSA63J-221X	MG RESISTOR		
	R 793	NRSA63J-221X	MG RESISTOR		
	R 794	NRSA63J-221X	MG RESISTOR		

RX-6012VSL
RX-6012VSL

A
A

■ Electrical parts list (System control & Audio board) Block No. 03

△	Item	Parts number	Parts name	Remarks	Area
	R 795	NRSA63J-221X	MG RESISTOR		
	R 796	NRSA63J-221X	MG RESISTOR		
	R 797	NRSA63J-221X	MG RESISTOR		
	R 798	NRSA63J-221X	MG RESISTOR		
	R 799	NRSA63J-221X	MG RESISTOR		
△	R1401	QRZ9005-100X	F RESISTOR	10 1/0W	
△	R1402	QRJ146J-182X	UNF C RESISTOR	1.8K 5% 1/4W	
△	R1403	QRZ9005-120X	F RESISTOR	12 1/0W	
△	R1404	QRJ146J-272X	UNF C RESISTOR	2.7K 5% 1/4W	
△	R1405	QRZ9005-120X	F RESISTOR	12 1/0W	
△	R1406	QRK126J-682X	UNF C RESISTOR	6.8K 5% 1/2W	
△	R1407	QRZ9006-4R7X	F RESISTOR	4.7 1/0W	
△	R1408	QRZ9006-4R7X	F RESISTOR	4.7 1/0W	
△	R1409	QRJ146J-272X	UNF C RESISTOR	2.7K 5% 1/4W	
△	R1410	QRZ9006-4R7X	F RESISTOR	4.7 1/0W	
△	R1411	QRJ146J-182X	UNF C RESISTOR	1.8K 5% 1/4W	
△	R1412	QRZ9005-100X	F RESISTOR	10 1/0W	
△	R1413	QRJ146J-102X	UNF C RESISTOR	1.0K 5% 1/4W	
△	R1414	QRZ9005-100X	F RESISTOR	10 1/0W	
△	R1415	QRJ146J-222X	UNF C RESISTOR	2.2K 5% 1/4W	
△	R1416	QRZ9005-100X	F RESISTOR	10 1/0W	
△	R1417	QRJ146J-222X	UNF C RESISTOR	2.2K 5% 1/4W	
△	R1418	QRZ9005-680X	F RESISTOR	68 1/0W	
△	R1419	QRZ9005-680X	F RESISTOR	68 1/0W	
	R1435	NRSA63J-154X	MG RESISTOR		
	R1436	NRSA63J-154X	MG RESISTOR		
	R1437	NRSA63J-102X	MG RESISTOR		
	R1438	NRSA63J-102X	MG RESISTOR		
	R1439	NRSA63J-103X	MG RESISTOR		
	R1440	NRSA63J-103X	MG RESISTOR		
	R1442	NRSA63J-104X	MG RESISTOR		
	R1444	NRSA63J-103X	MG RESISTOR		
	R1445	NRSA63J-102X	MG RESISTOR		
	R1446	NRSA63J-104X	MG RESISTOR		
	R1447	NRSA63J-102X	MG RESISTOR		
	R1448	NRSA63J-103X	MG RESISTOR		
	R1449	NRSA63J-102X	MG RESISTOR		
	R1450	NRSA63J-103X	MG RESISTOR		
	R1451	NRSA63J-104X	MG RESISTOR		
	R1452	NRSA63J-104X	MG RESISTOR		
	R1453	NRSA63J-102X	MG RESISTOR		
	R1454	NRSA63J-104X	MG RESISTOR		
	R1455	NRSA63J-104X	MG RESISTOR		
△	R1456	QRJ146J-220X	UNF C RESISTOR	22 5% 1/4W	
	R1457	NRSA63J-472X	MG RESISTOR		
	R1458	NRSA63J-472X	MG RESISTOR		
△	R1459	QRZ9005-680X	F RESISTOR	68 1/0W	
△	R1460	QRZ9005-680X	F RESISTOR	68 1/0W	
△	R1461	QRJ146J-2R2X	UNF C RESISTOR	2.2 5% 1/4W	
△	R1462	QRJ146J-2R2X	UNF C RESISTOR	2.2 5% 1/4W	
	R1463	NRSA63J-104X	MG RESISTOR		
	R1464	NRSA63J-104X	MG RESISTOR		
	R1465	NRSA63J-102X	MG RESISTOR		
	R1470	NRSA63J-391X	MG RESISTOR		
	R1471	NRSA63J-391X	MG RESISTOR		
	R1472	NRSA63J-103X	MG RESISTOR		
	R1473	NRSA63J-103X	MG RESISTOR		
	R1474	NRSA63J-102X	MG RESISTOR		
	R1480	NRSA63J-104X	MG RESISTOR		
	R1490	NRSA63J-273X	MG RESISTOR		
	R1492	NRSA63J-102X	MG RESISTOR		
	R1493	NRSA63J-102X	MG RESISTOR		
	R1494	NRSA63J-102X	MG RESISTOR		

△	Item	Parts number	Parts name	Remarks	Area
	R1495	NRSA63J-103X	MG RESISTOR		
	R1496	NRSA63J-103X	MG RESISTOR		
	R1497	NRSA63J-511X	MG RESISTOR		
	R1498	NRSA63J-511X	MG RESISTOR		
	R1499	NRSA63J-104X	MG RESISTOR		
	S 721	QSW0683-001Z	PUSH SWITCH	TUNING+	
	S 722	QSW0683-001Z	PUSH SWITCH	TUNING-	
	S 723	QSW0683-001Z	PUSH SWITCH	PRESET+	
	S 724	QSW0683-001Z	PUSH SWITCH	PRESET-	
	S 725	QSW0683-001Z	PUSH SWITCH	FM MODE	
	S 726	QSW0683-001Z	PUSH SWITCH	MEMORY	
	S 727	QSW0683-001Z	PUSH SWITCH	POWER	
	S 728	QSW0683-001Z	PUSH SWITCH	SURROUND	
	S 729	QSW0683-001Z	PUSH SWITCH	DSP MODE	
	S 732	QSW0683-001Z	PUSH SWITCH	SPK1	
	S 740	QSW0683-001Z	PUSH SWITCH	TV/DBS	
	S 741	QSW0683-001Z	PUSH SWITCH	FM/AM	
	S 742	QSW0683-001Z	PUSH SWITCH	ADJUST	
	S 743	QSW0683-001Z	PUSH SWITCH	SETTING	
	S 744	QSW0683-001Z	PUSH SWITCH	+	
	S 745	QSW0683-001Z	PUSH SWITCH	-	
	S 751	QSW0683-001Z	PUSH SWITCH	DIGITAL	
	S 752	QSW0683-001Z	PUSH SWITCH	ANALOG	
	S 754	QSW0683-001Z	PUSH SWITCH	DVD	
	S 755	QSW0683-001Z	PUSH SWITCH	CD	
	S 756	QSW0683-001Z	PUSH SWITCH	VCR	
	S 757	QSW0683-001Z	PUSH SWITCH	TAPE/CDR	
	X 701	QAX0246-001Z	RESONATOR		

■ Electrical parts list (DSP board)

Block No. 04

△	Item	Parts number	Parts name	Remarks	Area	△	Item	Parts number	Parts name	Remarks	Area
	C 601	NCB31HK-102X	C CAPACITOR				C2513	NCB31HK-122X	C CAPACITOR		
	C 602	NCB31HK-102X	C CAPACITOR				C2514	NCB31HK-122X	C CAPACITOR		
	C 603	QETN0JM-107Z	E CAPACITOR	100MF 20% 6.3V			C2515	NCS31HJ-121X	C CAPACITOR		
	C 604	QETN0JM-107Z	E CAPACITOR	100MF 20% 6.3V			C2516	NCS31HJ-121X	C CAPACITOR		
	C 605	NCF31CZ-104X	C CAPACITOR				C2517	NCS31HJ-391X	C CAPACITOR		
	C 606	NCF31CZ-104X	C CAPACITOR				C2518	NCS31HJ-391X	C CAPACITOR		
	C 607	QETN1CM-107Z	E CAPACITOR	100MF 20% 16V			C2525	NCB31HK-102X	C CAPACITOR		
	C 608	NCF31CZ-104X	C CAPACITOR				C2526	NCB31HK-102X	C CAPACITOR		
	C 609	NCF31CZ-104X	C CAPACITOR				C2527	QETN1HM-106Z	E CAPACITOR	10MF 20% 50V	
	C 610	QETN0JM-107Z	E CAPACITOR	100MF 20% 6.3V			C2528	QETN1HM-106Z	E CAPACITOR	10MF 20% 50V	
	C 611	QETN0JM-107Z	E CAPACITOR	100MF 20% 6.3V			C2531	NCS31HJ-560X	C CAPACITOR		
	C 612	NCB31CK-103X	C CAPACITOR				C2532	NCS31HJ-560X	C CAPACITOR		
	C 621	QETN1HM-105Z	E CAPACITOR	1.0MF 20% 50V			C2533	QETN1HM-475Z	E CAPACITOR	4.7MF 20% 50V	
	C 622	NCS31HJ-101X	C CAPACITOR				C2534	QETN1HM-475Z	E CAPACITOR	4.7MF 20% 50V	
	C 623	NCF31AZ-105X	C CAPACITOR				C2539	NCF31CZ-104X	C CAPACITOR		
	C 624	NCF31CZ-104X	C CAPACITOR				C2540	NCF31CZ-104X	C CAPACITOR		
	C 626	NCF31AZ-105X	C CAPACITOR				C2551	NCS31HJ-560X	C CAPACITOR		
	C 627	NCF31AZ-105X	C CAPACITOR				C2552	NCS31HJ-560X	C CAPACITOR		
	C 628	NCB31CK-103X	C CAPACITOR				C2555	NCF31CZ-104X	C CAPACITOR		
	C 631	QETN0JM-107Z	E CAPACITOR	100MF 20% 6.3V			C2556	NCF31CZ-104X	C CAPACITOR		
	C 632	NCB31CK-103X	C CAPACITOR				C2561	QETN1HM-105Z	E CAPACITOR	1.0MF 20% 50V	
	C 633	NCF31CZ-104X	C CAPACITOR				C2562	QETN1HM-105Z	E CAPACITOR	1.0MF 20% 50V	
	C 634	NCF31CZ-104X	C CAPACITOR				C2563	NCS31HJ-220X	C CAPACITOR		
	C 635	NCF31CZ-104X	C CAPACITOR				C2564	NCS31HJ-220X	C CAPACITOR		
	C 636	NCB31CK-473X	C CAPACITOR				C2569	NCF31CZ-104X	C CAPACITOR		
	C 638	QETN0JM-107Z	E CAPACITOR	100MF 20% 6.3V			C2570	NCF31CZ-104X	C CAPACITOR		
	C 639	NCB31CK-103X	C CAPACITOR				C2575	NCB31HK-102X	C CAPACITOR		
	C 641	QETN0JM-107Z	E CAPACITOR	100MF 20% 6.3V			C2576	NCB31HK-102X	C CAPACITOR		
	C 642	NCB31CK-103X	C CAPACITOR				C2577	QETN1HM-106Z	E CAPACITOR	10MF 20% 50V	
	C 643	NCB31AK-474X	C CAPACITOR				C2578	QETN1HM-106Z	E CAPACITOR	10MF 20% 50V	
	C 644	NCB31CK-103X	C CAPACITOR				C2581	QETN1HM-105Z	E CAPACITOR	1.0MF 20% 50V	
	C 645	NCS31HJ-101X	C CAPACITOR				C2582	QETN1CM-106Z	E CAPACITOR	10MF 20% 16V	
	C 646	NCB31CK-103X	C CAPACITOR				C2583	NCS31HJ-220X	C CAPACITOR		
	C 647	NCS31HJ-220X	C CAPACITOR				C2584	NCS31HJ-560X	C CAPACITOR		
	C 648	NCS31HJ-180X	C CAPACITOR				C2585	NCF31CZ-104X	C CAPACITOR		
	C 649	NCS31HJ-121X	C CAPACITOR				C2586	NCF31CZ-104X	C CAPACITOR		
	C 653	NCB31CK-104X	C CAPACITOR				C2587	NCS31HJ-560X	C CAPACITOR		
	C 654	QETN0JM-107Z	E CAPACITOR	100MF 20% 6.3V			C2588	QETN1HM-475Z	E CAPACITOR	4.7MF 20% 50V	
	C 661	NCB31CK-103X	C CAPACITOR				C2589	NCF31CZ-104X	C CAPACITOR		
	C 671	NCB31CK-103X	C CAPACITOR				C2590	NCF31CZ-104X	C CAPACITOR		
	C 672	QETN0JM-107Z	E CAPACITOR	100MF 20% 6.3V			C2592	NCB31HK-223X	C CAPACITOR		
	C 673	NCB31CK-103X	C CAPACITOR				C2594	NCF31CZ-104X	C CAPACITOR		
	C 677	NCS31HJ-101X	C CAPACITOR				C2595	NCB31HK-102X	C CAPACITOR		
	C 679	NCS31HJ-101X	C CAPACITOR				C2597	QETN1HM-106Z	E CAPACITOR	10MF 20% 50V	
	C 681	NCB31CK-103X	C CAPACITOR				C2598	QETN1HM-475Z	E CAPACITOR	4.7MF 20% 50V	
	C 682	NCB31CK-103X	C CAPACITOR				D 607	1SS355-X	DIODE		
	C 683	NCB31CK-103X	C CAPACITOR				D 608	1SS355-X	DIODE		
	C 684	QETN0JM-107Z	E CAPACITOR	100MF 20% 6.3V			IC601	AK4527BVQ	IC		
	C 685	QETN1CM-476Z	E CAPACITOR	47MF 20% 16V			IC609	BA15218F-XE	IC		
	C 686	QETN1CM-476Z	E CAPACITOR	47MF 20% 16V			IC610	BA15218F-XE	IC		
	C 687	NCB31CK-103X	C CAPACITOR				IC611	BU4066BCF-X	IC		
	C 688	QETN0JM-107Z	E CAPACITOR	100MF 20% 6.3V			IC621	TC7SU04FU-X	IC		
	C 689	NCB31CK-103X	C CAPACITOR				IC622	TC7SU04FU-X	IC		
	C 690	QETN0JM-107Z	E CAPACITOR	100MF 20% 6.3V			IC631	TC9446F-014	IC		
	C 693	NCB31CK-103X	C CAPACITOR				IC641	W24L010AJ-12-X	IC		
	C 694	NCF31CZ-104X	C CAPACITOR				IC650	BA15218F-XE	IC		
	CN681	QGB2510K1-20	B TO B CONNE				IC651	BA15218F-XE	IC		
	C2500	QETN1CM-226Z	E CAPACITOR	22MF 20% 16V			IC652	IMX9-W	TRANSISTOR		
	C2503	QETN1HM-475Z	E CAPACITOR	4.7MF 20% 50V			IC661	BA15218F-XE	IC		
	C2504	QETN1HM-475Z	E CAPACITOR	4.7MF 20% 50V			IC662	IMX9-W	TRANSISTOR		
	C2507	NCS31HJ-330X	C CAPACITOR				IC671	UPD784215AGC103	IC		
	C2508	NCS31HJ-330X	C CAPACITOR				IC672	TC7SET32FU-X	IC		
	C2512	NCF31CZ-104X	C CAPACITOR				IC681	PQ3DZ53-X	IC		

■ Electrical parts list (DSP board)

Block No. 04

△	Item	Parts number	Parts name	Remarks	Area	△	Item	Parts number	Parts name	Remarks	Area
	IC682	IMX9-W	TRANSISTOR			R 683	NRSA63J-0R0X	MG RESISTOR			
	IC683	RN5RZ33BA-X	IC			R 684	NRSA63J-0R0X	MG RESISTOR			
	IC690	BA15218F-XE	IC			R 685	NRSA63J-103X	MG RESISTOR			
	IC691	BA15218F-XE	IC			R 686	NRSA63J-151X	MG RESISTOR			
	J 601	QNN0347-001	PIN JACK			R 687	NRSA63J-0R0X	MG RESISTOR			
	K 601	NQR0269-004X	FERRITE BEADS			R 688	NRSA63J-0R0X	MG RESISTOR			
	Q 607	DTA144EKA-X	TRANSISTOR			R 689	NRSA63J-0R0X	MG RESISTOR			
	Q 670	DTC114YE-X	TRANSISTOR			R 691	NRSA63J-221X	MG RESISTOR			
	Q 671	2SD2114K/VW/-X	CHIP TRANSISTOR			R 692	NRSA63J-221X	MG RESISTOR			
	Q 672	DTC114YE-X	TRANSISTOR			R 693	NRSA63J-221X	MG RESISTOR			
	Q 673	DTA144EKA-X	TRANSISTOR			R 694	NRSA63J-221X	MG RESISTOR			
	Q2501	DTA144EKA-X	TRANSISTOR			R 695	NRSA63J-221X	MG RESISTOR			
	R 600	NRSA63J-0R0X	MG RESISTOR			R 696	NRSA63J-221X	MG RESISTOR			
	R 601	NRSA63J-473X	MG RESISTOR			R 697	NRSA63J-0R0X	MG RESISTOR			
	R 602	NRSA63J-473X	MG RESISTOR			R 698	NRSA63J-0R0X	MG RESISTOR			
	R 603	NRSA63J-473X	MG RESISTOR			R2500	NRSA63J-102X	MG RESISTOR			
	R 606	NRSA63J-221X	MG RESISTOR			R2501	NRSA63J-104X	MG RESISTOR			
	R 607	NRSA63J-221X	MG RESISTOR			R2502	NRSA63J-104X	MG RESISTOR			
	R 608	NRSA63J-221X	MG RESISTOR			R2507	NRSA63J-223X	MG RESISTOR			
	R 609	NRSA63J-221X	MG RESISTOR			R2508	NRSA63J-223X	MG RESISTOR			
	R 611	NRSA63J-221X	MG RESISTOR			R2509	NRSA63J-223X	MG RESISTOR			
	R 612	NRSA63J-221X	MG RESISTOR			R2510	NRSA63J-223X	MG RESISTOR			
	R 613	NRSA63J-822X	MG RESISTOR			R2511	NRSA63J-103X	MG RESISTOR			
	R 615	NRSA63J-432X	MG RESISTOR			R2512	NRSA63J-103X	MG RESISTOR			
	R 617	NRSA63J-103X	MG RESISTOR			R2513	NRSA63J-103X	MG RESISTOR			
	R 618	NRSA63J-103X	MG RESISTOR			R2514	NRSA63J-103X	MG RESISTOR			
	R 620	NRSA63J-221X	MG RESISTOR			R2515	NRSA63J-103X	MG RESISTOR			
	R 621	NRSA63J-221X	MG RESISTOR			R2516	NRSA63J-103X	MG RESISTOR			
	R 622	NRSA63J-750X	MG RESISTOR			R2517	NRSA63J-103X	MG RESISTOR			
	R 623	NRSA63J-101X	MG RESISTOR			R2518	NRSA63J-103X	MG RESISTOR			
	R 627	NRSA63J-472X	MG RESISTOR			R2519	NRSA63J-331X	MG RESISTOR			
	R 628	NRSA63J-183X	MG RESISTOR			R2520	NRSA63J-331X	MG RESISTOR			
	R 631	NRSA63J-0R0X	MG RESISTOR			R2521	NRSA63J-331X	MG RESISTOR			
	R 632	NRSA63J-0R0X	MG RESISTOR			R2522	NRSA63J-331X	MG RESISTOR			
	R 639	NRSA63J-472X	MG RESISTOR			R2525	NRSA63J-102X	MG RESISTOR			
	R 640	NRSA63J-0R0X	MG RESISTOR			R2526	NRSA63J-102X	MG RESISTOR			
	R 641	NRSA63F-102X	MG RESISTOR			R2527	NRSA63J-104X	MG RESISTOR			
	R 642	NRSA63J-103X	MG RESISTOR			R2528	NRSA63J-104X	MG RESISTOR			
	R 643	NRSA63J-101X	MG RESISTOR			R2529	NRSA63J-103X	MG RESISTOR			
	R 644	NRSA63J-153X	MG RESISTOR			R2530	NRSA63J-103X	MG RESISTOR			
	R 645	NRSA63F-102X	MG RESISTOR			R2531	NRSA63J-752X	MG RESISTOR			
	R 646	NRSA63J-103X	MG RESISTOR			R2532	NRSA63J-752X	MG RESISTOR			
	R 647	NRSA63J-225X	MG RESISTOR			R2533	NRSA63J-103X	MG RESISTOR			
	R 648	NRSA63J-472X	MG RESISTOR			R2534	NRSA63J-103X	MG RESISTOR			
	R 657	NRSA63J-103X	MG RESISTOR			R2535	NRSA63J-103X	MG RESISTOR			
	R 661	NRSA63J-221X	MG RESISTOR			R2536	NRSA63J-103X	MG RESISTOR			
	R 662	NRSA63J-221X	MG RESISTOR			R2537	NRSA63J-104X	MG RESISTOR			
	R 663	NRSA63J-221X	MG RESISTOR			R2538	NRSA63J-104X	MG RESISTOR			
	R 664	NRSA63J-221X	MG RESISTOR			R2550	NRSA63J-272X	MG RESISTOR			
	R 669	NRSA63J-103X	MG RESISTOR			R2551	NRSA63J-103X	MG RESISTOR			
	R 670	NRSA63J-103X	MG RESISTOR			R2552	NRSA63J-103X	MG RESISTOR			
	R 671	NRSA63J-103X	MG RESISTOR			R2553	NRSA63J-153X	MG RESISTOR			
	R 672	NRSA63J-105X	MG RESISTOR			R2554	NRSA63J-153X	MG RESISTOR			
	R 673	NRSA63J-432X	MG RESISTOR			R2555	NRSA63J-822X	MG RESISTOR			
	R 674	NRSA63J-432X	MG RESISTOR			R2556	NRSA63J-822X	MG RESISTOR			
	R 675	NRSA63J-432X	MG RESISTOR			R2557	NRSA63J-103X	MG RESISTOR			
	R 676	NRSA63J-432X	MG RESISTOR			R2558	NRSA63J-223X	MG RESISTOR			
	R 677	NRSA63J-822X	MG RESISTOR			R2560	NRSA63J-105X	MG RESISTOR			
	R 678	NRSA63J-822X	MG RESISTOR			R2561	NRSA63J-104X	MG RESISTOR			
	R 679	NRSA63J-822X	MG RESISTOR			R2562	NRSA63J-104X	MG RESISTOR			
	R 680	NRSA63J-822X	MG RESISTOR			R2563	NRSA63J-103X	MG RESISTOR			
	R 681	NRSA63J-103X	MG RESISTOR			R2564	NRSA63J-103X	MG RESISTOR			
	R 682	NRSA63J-103X	MG RESISTOR			R2565	NRSA63J-202X	MG RESISTOR			

■ Electrical parts list (DSP board)

Block No. 04

△	Item	Parts number	Parts name	Remarks	Area
	R2566	NRSA63J-202X	MG RESISTOR		
	R2567	NRSA63J-103X	MG RESISTOR		
	R2568	NRSA63J-103X	MG RESISTOR		
	R2575	NRSA63J-102X	MG RESISTOR		
	R2576	NRSA63J-102X	MG RESISTOR		
	R2577	NRSA63J-104X	MG RESISTOR		
	R2578	NRSA63J-104X	MG RESISTOR		
	R2581	NRSA63J-104X	MG RESISTOR		
	R2582	NRSA63J-104X	MG RESISTOR		
	R2583	NRSA63J-123X	MG RESISTOR		
	R2584	NRSA63J-223X	MG RESISTOR		
	R2585	NRSA63J-302X	MG RESISTOR		
	R2586	NRSA63J-332X	MG RESISTOR		
	R2587	NRSA63J-103X	MG RESISTOR		
	R2588	NRSA63J-103X	MG RESISTOR		
	R2589	NRSA63J-104X	MG RESISTOR		
	R2590	NRSA63J-333X	MG RESISTOR		
	R2592	NRSA63J-333X	MG RESISTOR		
	R2594	NRSA63J-333X	MG RESISTOR		
	R2595	NRSA63J-102X	MG RESISTOR		
	R2596	NRSA63J-102X	MG RESISTOR		
	R2597	NRSA63J-104X	MG RESISTOR		
	R2598	NRSA63J-104X	MG RESISTOR		
	UN661	GP1FA550RZ	OPT RECEIVER		
	X 631	NAX0385-001X	CRYSTAL		
	X 671	NAX0275-001X	1COSCIALLATOR		

■ Electrical parts list (Tuner board)

Block No. 05

△	Item	Parts number	Parts name	Remarks	Area
	AT101	QNB0014-001	ANT TERMINAL		
	BK 1	LV31618-001A	SHIELD BKT		
	C 101	NCB21HK-103X	C CAPACITOR		
	C 103	NCB21HK-223X	C CAPACITOR		
	C 105	NCB21HK-223X	C CAPACITOR		
	C 107	QEK1CM-226Z	E CAPACITOR	22MF 20% 16V	
	C 111	NCB21HK-473X	C CAPACITOR		
	C 112	NDC21HJ-120X	C CAPACITOR		
	C 121	NDC21HJ-120X	C CAPACITOR		
	C 122	NDC21HJ-120X	C CAPACITOR		
	C 123	NCB21HK-473X	C CAPACITOR		
	C 126	NCS21HJ-101X	C CAPACITOR		
	C 128	QENC1HM-474Z	NP E CAPACITOR	.47MF 20% 50V	
	C 129	NCB21HK-102X	C CAPACITOR		
	C 130	QEK1AM-107Z	E CAPACITOR	100MF 20% 10V	
	C 133	QEK1CM-226Z	E CAPACITOR	22MF 20% 16V	
	C 134	NCB21HK-222X	C CAPACITOR		
	C 135	NCB21HK-223X	C CAPACITOR		
	C 136	QEK1HM-105Z	E CAPACITOR	1.0MF 20% 50V	
	C 137	NCB21HK-331X	C CAPACITOR		
	C 138	NCB21HK-473X	C CAPACITOR		
	C 139	NCB21HK-223X	C CAPACITOR		
	C 140	NCB21HK-223X	C CAPACITOR		
	C 141	NCB21HK-473X	C CAPACITOR		
	C 143	NCB21HK-223X	C CAPACITOR		
	C 144	NCB21HK-473X	C CAPACITOR		
	C 146	QEK1HM-105Z	E CAPACITOR	1.0MF 20% 50V	
	C 147	QEK1HM-105Z	E CAPACITOR	1.0MF 20% 50V	
	C 148	QEK1HM-224Z	E CAPACITOR	.22MF 20% 50V	
	C 149	QEK1HM-105Z	E CAPACITOR	1.0MF 20% 50V	
	C 150	QEK1CM-226Z	E CAPACITOR	22MF 20% 16V	
	C 156	QDGB1HK-102Y	C CAPACITOR		
	C 157	NCB21HK-473X	C CAPACITOR		
	C 158	QEK1CM-226Z	E CAPACITOR	22MF 20% 16V	
	C 161	QEK1CM-106Z	E CAPACITOR	10MF 20% 16V	
	C 162	QEK1CM-106Z	E CAPACITOR	10MF 20% 16V	
	C 163	NCB21HK-223X	C CAPACITOR		
	C 164	NCB21HK-473X	C CAPACITOR		
	C 168	QEK1HM-105Z	E CAPACITOR	1.0MF 20% 50V	
	C 184	QEK1CM-107Z	E CAPACITOR	100MF 20% 16V	
	C 185	QEK1CM-106Z	E CAPACITOR	10MF 20% 16V	
	C 186	QEK1CM-106Z	E CAPACITOR	10MF 20% 16V	
	CF101	QAX0419-001Z	C FILTER		
	CF102	QAX0604-001Z	C FILTER		
	CF103	QAX0519-001Z	C FILTER		
	CN111	QGB2501K2-12	CONECTOR		
	D 121	1SS133-T2	SI DIODE		
	D 123	1SS133-T2	SI DIODE		
	D 129	1SS133-T2	SI DIODE		
	IC102	LA1838	IC		
	IC121	LC72136N	IC		
	Q 102	2SC535/BC/-T	TRANSISTOR		
	Q 103	2SC461/BC/-T	TRANSISTOR		
	Q 121	KRA103M-T	TRANSISTOR	FM+B	
	R 103	NRSA02J-221X	MG RESISTOR		
	R 104	NRSA02J-272X	MG RESISTOR		
	R 105	NRSA02J-391X	MG RESISTOR		
	R 106	NRSA02J-102X	MG RESISTOR		
	R 107	NRSA02J-391X	MG RESISTOR		
	R 108	NRSA02J-332X	MG RESISTOR		
	R 109	NRSA02J-221X	MG RESISTOR		
	R 115	NRSA02J-104X	MG RESISTOR		
	R 119	NRSA02J-103X	MG RESISTOR		

△	Item	Parts number	Parts name	Remarks	Area
	R 122	NRSA02J-472X	MG RESISTOR		
	R 124	NRSA02J-222X	MG RESISTOR		
	R 126	NRSA02J-562X	MG RESISTOR		
	R 127	NRSA02J-822X	MG RESISTOR		
	R 128	NRSA02J-472X	MG RESISTOR		
	R 129	NRSA02J-222X	MG RESISTOR		
△	R 130	QRZ9005-680X	F RESISTOR	68 1/0W	
	R 132	NRSA02J-393X	MG RESISTOR		
	R 133	NRSA02J-392X	MG RESISTOR		
	R 134	NRSA02J-102X	MG RESISTOR		
	R 140	NRSA02J-183X	MG RESISTOR		
	R 141	NRSA02J-102X	MG RESISTOR		
	R 142	NRSA02J-470X	MG RESISTOR		
	R 143	NRSA02J-562X	MG RESISTOR		
	R 144	NRSA02J-332X	MG RESISTOR		
	R 145	NRSA02J-103X	MG RESISTOR		
	R 146	NRSA02J-392X	MG RESISTOR		
	R 147	NRSA02J-332X	MG RESISTOR		
	R 150	NRSA02J-331X	MG RESISTOR		
	R 157	NRSA02J-682X	MG RESISTOR		
	R 158	NRSA02J-682X	MG RESISTOR		
	R 161	NRSA02J-102X	MG RESISTOR		
	R 162	NRSA02J-102X	MG RESISTOR		
	R 182	NRSA02J-103X	MG RESISTOR		
	R 183	NRSA02J-103X	MG RESISTOR		
	R 184	NRSA02J-103X	MG RESISTOR		
	RF101	QAU0124-002	FRONT END		
	T 111	QQR0796-001	COIL BLOCK		
	T 142	QQR0973-001	IFT		
	X 121	QAX0402-001	CRYSTAL		

Packing materials and accessories parts list

Block No.

M	2	M	M
---	---	---	---

Block No.

M	3	M	M
---	---	---	---

Ver.UJ/UP/US

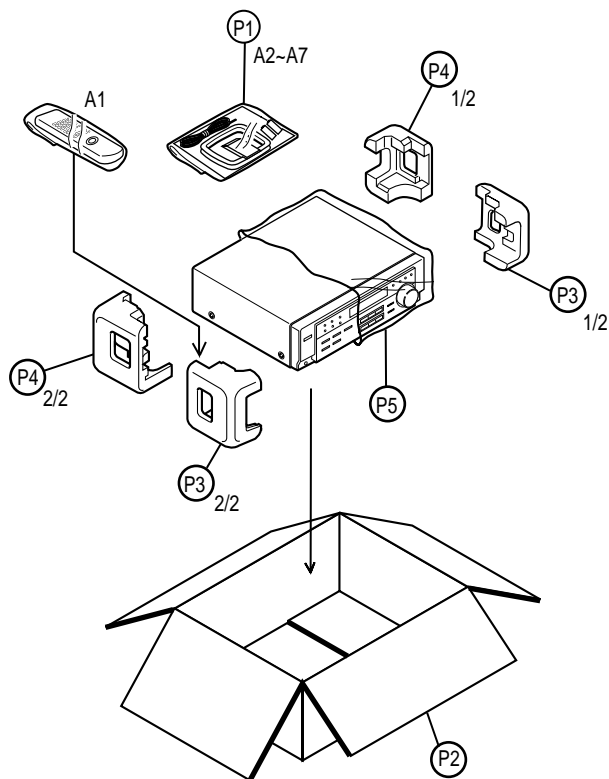

Ver.A/UY

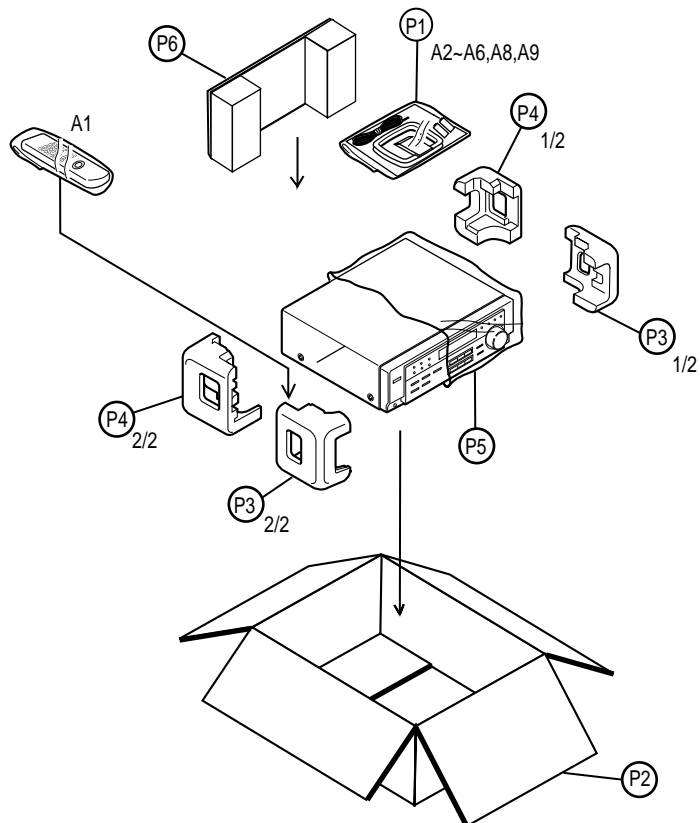

■ Parts list (Packing)

Block No. M2MM

△	Item	Parts number	Parts name	Q'ty	Description	Area
	P 1	QPA02503505P	POLY BAG	1	FOR INST	
	P 2	LV20983-007A	PACKING CASE	1	RX-6012VSL	US, UP
		LV20983-018A	PACKING CASE	1	RX-6012VSL	A, UY
		LV20983-002A	PACKING CASE	1	RX-6010VBK	UJ
	P 3	LV20925-001A	PACKING PAD	1		
	P 4	LV20926-001A	PACKING PAD	1		
	P 5	QPC06507015P	POLY BAG	1	FOR SET	
	P 6	LV30385-004A	PACKING SHEET	1	RX-6012VSL	A, UY

■ Parts list (Accessories)

Block No. M3MM

△	Item	Parts number	Parts name	Q'ty	Description	Area
	A 1	RM-SRX6012U	REMOCON	1	RX-6012VSL	
		RM-SRX6010U	W.LESS REMOCON	1	RX-6010VBK	
	A 2	-----	BATTERY	2		
	A 3	LVT0578-009A	INST BOOK	1	ENG	A
		LVT0578-003A	INST BOOK	1	ENG, SPA, POR, CHI	UJ
		LVT0578-003A	INST BOOK	1	ENG, SPA, POR, CHI	US
		LVT0578-012A	INST BOOK	1	SPA	UY
		LVT0578-010A	INST BOOK	1	KOR	UP
	A 4	EWP503-001C	ANT.WIRE	1		
	A 5	QAL0204-001	AM LOOP ANT	1		
	A 6	QAM0112-001	AC PLUG ADAPTER	1	RX-6012VSL	US
		QAM0112-001	AC PLUG ADAPTER	1	RX-6010VBK	UJ
	A 7	BT-56010-1	WARRANTY CARD	1	RX-6012VSL	UP
	A 8	BT-56001-2	WARRANTY CARD	1	RX-6012VSL	A
	A 9	BT-56002-2	SERVICE NETWORK	1	RX-6012VSL	A



VICTOR COMPANY OF JAPAN, LIMITED

AUDIO & COMMUNICATION BUSINESS DIVISION

PERSONAL & MOBILE NETWORK BUSINESS UNIT. 10-1,1chome,Ohwatari-machi,Maebashi-city,371-8543,Japan

JVC



AUDIO/VIDEO CONTROL RECEIVER

RECEPTOR DE CONTROL DE AUDIO/VÍDEO

RECEPTOR DE COMANDO AUDIO/VÍDEO

AV功率放大器（带收音）

RX-6010VBK / RX-6012VSL

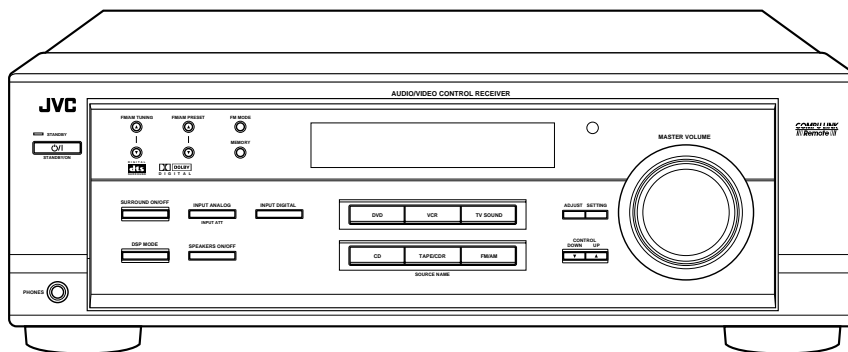
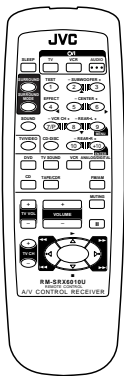

COMPU LINK
Remote

DIGITAL
dts
SURROUND

DOLBY
DIGITAL

INSTRUCTIONS

MANUAL DE INSTRUCCIONES
INSTRUÇÕES
使用说明书

For Customer Use:

Enter below the Model No. and Serial No. which are located either on the rear, bottom or side of the cabinet. Retain this information for future reference.

Model No. _____

Serial No. _____

LVT0578-003A
[US, UN, UJ]

Warnings, Cautions and Others / Avisos, precauciones y otras notas / Advertências, precauções e outras notas / 警告、注意及其他須知事項

Caution — ⏻/I switch!

Disconnect the mains plug to shut the power off completely. The ⏻/I switch in any position does not disconnect the mains line. The power can be remote controlled.

Precaución — Interruptor ⏻/I!

Desconectar el cable de alimentación para desactivar la alimentación totalmente. Cualquier que sea la posición de ajuste del interruptor ⏻/I, la alimentación no es cortada completamente. La alimentación puede ser controlada remotamente.

Precaução — Interruptor ⏻/I!

Desconectar o cabo de alimentação para desligar a alimentação por completo. Qualquer que seja a posição de ajuste do interruptor ⏻/I, a alimentação não é completamente cortada. A alimentação pode ser controlada remotamente.

注意 — ⏻/I 按键

无论 ⏻/I 按键在任何位置，电源线的电源还是没有被切断，若要电源完全关闭，应将电源插头拔离插座。电源可用遥控器控制。

CAUTION

To reduce the risk of electrical shocks, fire, etc.:

1. Do not remove screws, covers or cabinet.
2. Do not expose this appliance to rain or moisture.

ATENÇÃO

Para reduzir riscos de choques eléctricos, incêndio, etc.:

1. Não retire parafusos nem desmonte as tampas ou o gabinete.
2. Não exponha este aparelho à chuva nem à umidade.

CAUTION

- Do not block the ventilation openings or holes. (If the ventilation openings or holes are blocked by a newspaper or cloth, etc., the heat may not be able to get out.)
- Do not place any naked flame sources, such as lighted candles, on the apparatus.
- When discarding batteries, environmental problems must be considered and local rules or laws governing the disposal of these batteries must be followed strictly.
- Do not use this apparatus in a bathroom or places with water. Also do not place any containers filled with water or liquids (such as cosmetics or medicines, flower vases, potted plants, cups, etc.) on top of this apparatus.

AVISO

- Não obstrua as aberturas e orifícios de ventilação. (Se os orifícios ou aberturas de ventilação estiverem obstruídos por qualquer papel ou tecido, não haverá circulação do ar quente.)
- Não coloque nenhum objeto com chamas, como velas acesas, sobre o aparelho.
- Ao descartar as baterias, leve em consideração os problemas que possam ser causados ao meio ambiente e os regulamentos e leis locais e governamentais sobre recolhimento dessas baterias devem ser rigorosamente seguidos.
- Não utilize este aparelho em banheiros ou em locais com água. Além disso, não coloque nenhum recipiente com água ou qualquer tipo de líquido (como cosméticos ou remédios, vasos com flores, plantas, xícaras, etc.) sobre o aparelho.

PRECAUCIÓN

Para reducir riesgos de choques eléctricos, incendio, etc.:

1. No extraiga los tornillos, los cubiertas ni la caja.
2. No exponga este aparato a la lluvia o a la humedad.

警告

为了减低触电，火灾等危险：

1. 请勿擅自卸下螺丝钉，盖子或机壳。
2. 切勿让本机受雨淋或置潮湿环境中。

PRECAUCION

- No obstruya las rendijas o los orificios de ventilación. (Si las rendijas o los orificios de ventilación quedan tapados con un periódico, un trozo de tela, etc., no se podrá disipar el calor).
- No ponga sobre el aparato ninguna llama al descubierto, como velas encendidas.
- Cuando tenga que descartar las pilas, tenga en cuenta los problemas ambientales y observe estrictamente los reglamentos o las leyes locales sobre disposición de las pilas.
- No utilice este aparato en el cuarto de baño o en lugares donde hay agua. Tampoco coloque ningún recipiente que contenga agua u otros líquidos (frascos de cosméticos o medicinas, floreros, macetas, vasos, etc.) encima de este aparato.

注意

- 请勿堵塞通风口或通风孔。
(如果通风口或通风孔被报纸或布等堵塞，热量将无法散出。)
- 请勿在本设备上放置任何裸露的火源，如点燃的蜡烛。
- 处理废弃电池时，必须考虑环境问题，并严格遵守当地关于处理废弃电池的有关法律或规定。
- 请勿在浴室里或有水汽的地方使用本设备。亦请勿在本设备的上方放置任何装有水或液体的容器（如化妆品，药品，花瓶，花盆，杯子等）。

Caution: Proper Ventilation

To avoid risk of electric shock and fire and to protect from damage.

Locate the apparatus as follows:

- Front: No obstructions open spacing.
 - Sides: No obstructions in 10 cm from the sides.
 - Top: No obstructions in 10 cm from the top.
 - Back: No obstructions in 15 cm from the back
 - Bottom: No obstructions, place on the level surface.
- In addition, maintain the best possible air circulation as illustrated.

Precaución: Ventilación Adecuada

Para evitar el riesgo de choque eléctrico e incendio y para proteger el aparato contra daños.

Ubique el aparato de la siguiente manera:

- Frente: Espacio abierto sin obstrucciones
- Lados: 10 cm sin obstrucciones a los lados
- Parte superior: 10 cm sin obstrucciones en la parte superior
- Parte trasera: 15 cm sin obstrucciones en la parte trasera
- Fondo: Sin obstrucciones, colóquelo sobre una superficie nivelada

Además, mantenga la mejor circulación de aire posible como se ilustra.

Precaução: ventilação apropriada

Para prevenir o risco de choque elétrico ou incêndio e para proteger o aparelho contra danos.

Localize-o da seguinte maneira:

- Frente: Espaço aberto, sem obstruções
- Lados: Espaço de 10 cm sem obstruções nos lados
- Topo: Espaço de 10 cm sem obstruções acima
- Atrás: Espaço de 15 cm sem obstruções atrás
- Parte inferior: Sem obstruções. Coloque o aparelho em superfície nivelada.

Mantenha, além disso, a maior circulação de ar possível, como indica a ilustração.

注意：正确的通风方法

为了防止触电、火灾以及避免损坏，按如下要求放置机器：

- 前面：留下空间不要放置障碍物。
- 侧面：侧面的10 cm之内不要放置障碍物。
- 上面：上面的10 cm之内不要放置障碍物。
- 背面：背面的15 cm之内不要放置障碍物。
- 底部：不要放置障碍物，水平放置。

此外、如图所示，尽可能保持最佳的空气循环。

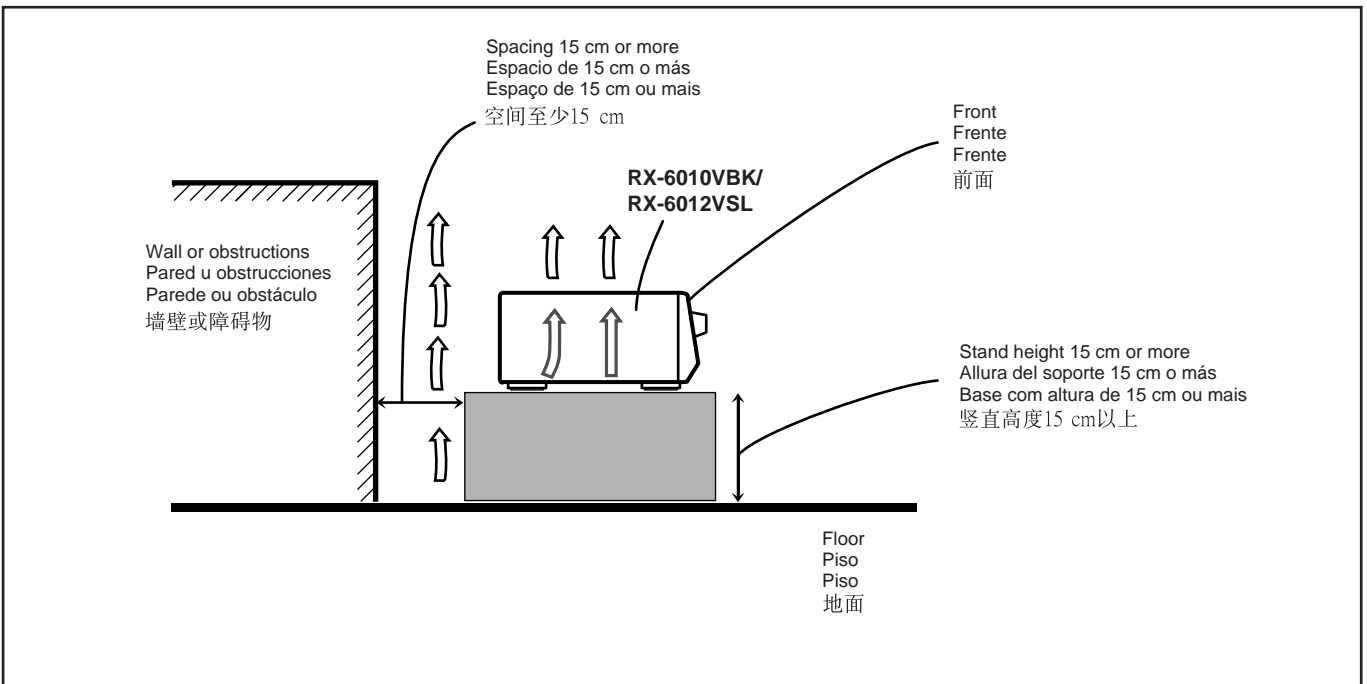
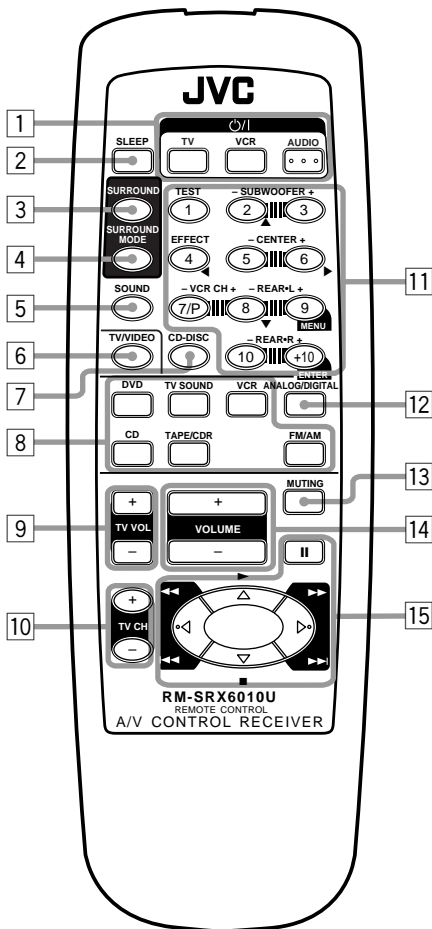
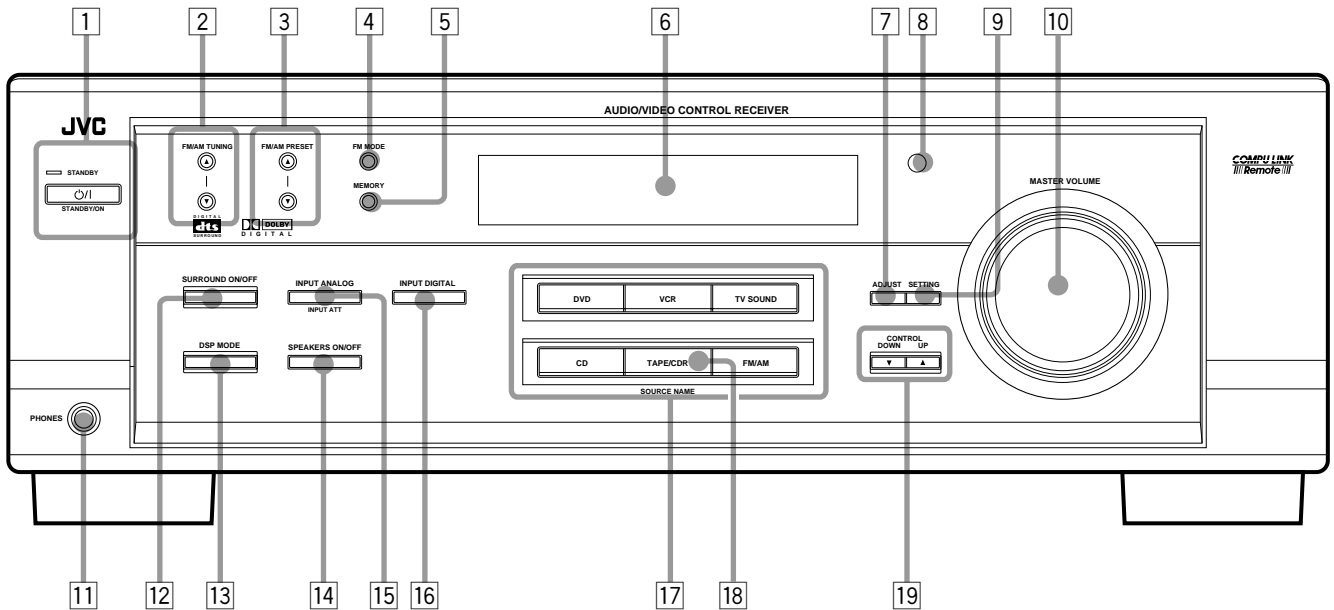

Table of Contents

Parts Identification	2
Getting Started	3
Before Installation	3
Checking the Supplied Accessories	3
Setting the Voltage Selector Switch	3
Connecting the FM and AM Antennas	3
Connecting the Speakers	4
Connecting Audio/Video Components	5
Connecting the Power Cord	7
Putting Batteries in the Remote Control	7
Basic Operations	8
Turning the Power On and Off (Standby)	8
Selecting the Source to Play	8
Adjusting the Volume	9
Listening Only with Headphones	9
Muting the Sound	9
Adjusting the Subwoofer Output Level	10
Attenuating the Input Signal	10
Adjusting the Tone	10
Basic Settings	11
Recording a Source	11
Adjusting the Front Speaker Output Balance	11
Setting the Subwoofer Information	11
Changing the Source Name	11
Setting the Speakers for the DSP Modes	12
Digital Input (DIGITAL IN) Terminal Setting	14
Selecting the Analog or Digital Input Mode	14
Storing the Basic Settings and Adjustments	15
Using the Sleep Timer	15
Receiving Radio Broadcasts	16
Setting the AM Tuner Interval Spacing	16
Tuning in Stations Manually	16
Using Preset Tuning	16
Selecting the FM Reception Mode	17
Using the DSP Modes	18
What are the DSP Modes?	18
Reproducing the Sound Field	19
Available DSP Modes According to the Speaker Arrangement ..	20
Adjusting the Surround Modes	21
Adjusting the DAP Modes	23
Activating the DSP Modes	24
COMPU LINK Remote Control System	25
Operating JVC's Audio/Video Components ...	26
Operating Audio Components	26
Operating Video Components	27
Troubleshooting	28
Specifications	29

Parts Identification

Become familiar with the buttons and controls on the receiver before use.
Refer to the pages in parentheses for details.



Remote Control

- 1 \odot/I (standby/on) buttons (8, 27)
TV, VCR, AUDIO
- 2 SLEEP button (15)
- 3 SURROUND button (21, 24, 26)
- 4 SURROUND MODE button
(22 – 24, 26)
- 5 SOUND button (10, 21 – 23, 26)
- 6 TV/VIDEO button (27)
- 7 CD-DISC button (27)
- 8 Source selecting buttons (8, 9, 15)
DVD, TV SOUND, VCR, CD,
TAPE/CDR, FM/AM
- 9 TV VOL +/- buttons (27)
- 10 TV CH +/- buttons (27)
- 11 • 10 keys for selecting preset channels
(17)
- 12 • 10 keys for adjusting sound
(21 – 23, 26)
- 13 • 10 keys for operating audio/video
components (26, 27)
- 12 ANALOG/DIGITAL button (15)
- 13 MUTING button (9)
- 14 VOLUME +/- buttons (9)
- 15 Operating buttons for audio/video
components (26, 27)

Front Panel

- 1 STANDBY/ON \odot/I button and
STANDBY lamp (8)
- 2 FM/AM TUNING $\blacktriangle/\blacktriangledown$ buttons (16)
- 3 FM/AM PRESET $\blacktriangle/\blacktriangledown$ buttons (16, 17)
- 4 FM MODE button (17)
- 5 MEMORY button (16)
- 6 Display (8)
- 7 ADJUST button (10, 11, 21 – 23)
- 8 Remote sensor (7)
- 9 SETTING button (11 – 14)
- 10 MASTER VOLUME control (9)
- 11 PHONES jack (9)
- 12 SURROUND ON/OFF button (21, 24)
- 13 DSP MODE button (22 – 24)
- 14 SPEAKERS ON/OFF button (9)
- 15 INPUT ANALOG button (15)
INPUT ATT button (10)
- 16 INPUT DIGITAL button (14)
- 17 Source selecting buttons (8, 9, 14)
DVD, VCR, TV SOUND, CD,
TAPE/CDR, FM/AM
- 18 SOURCE NAME button (11)
*TAPE/CDR button also functions as
the SOURCE NAME button.
- 19 CONTROL UP \blacktriangle /DOWN \blacktriangledown buttons

Getting Started

This section explains how to connect audio/video components and speakers to the receiver, and how to connect the power supply.

Before Installation

General

- Be sure your hands are dry.
- Turn the power off to all components.
- Read the manuals supplied with the components you are going to connect.

Locations

- Install the receiver in a location that is level and protected from moisture.
- The temperature around the receiver must be between -5°C and 35°C (23°F and 95°F).
- Make sure there is good ventilation around the receiver. Poor ventilation could cause overheating and damage the receiver.

Handling the receiver

- Do not insert any metal object into the receiver.
- Do not disassemble the receiver or remove screws, covers, or cabinet.
- Do not expose the receiver to rain or moisture.

Checking the Supplied Accessories

Check to be sure you have all of the following items, which are supplied with the receiver.

The number in the parentheses indicates the quantity of the pieces supplied.

- Remote Control (1)
- Batteries (2)
- AM Loop Antenna (1)
- FM Antenna (1)
- AC Plug Adaptor (1)

If anything is missing, contact your dealer immediately.

Setting the Voltage Selector Switch

Before connections, always do the following first if necessary.

Set the correct voltage for your area with the voltage selector switch on the rear panel. Rotate the voltage selector using a screw driver, so the voltage number the voltage mark is set at is the same as the voltage where you are plugging in the receiver.

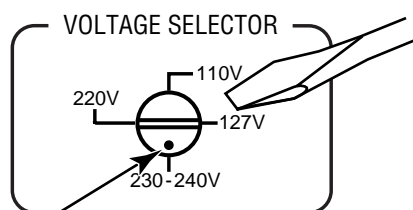

Voltage mark

Connecting the FM and AM Antennas

FM Antenna Connections

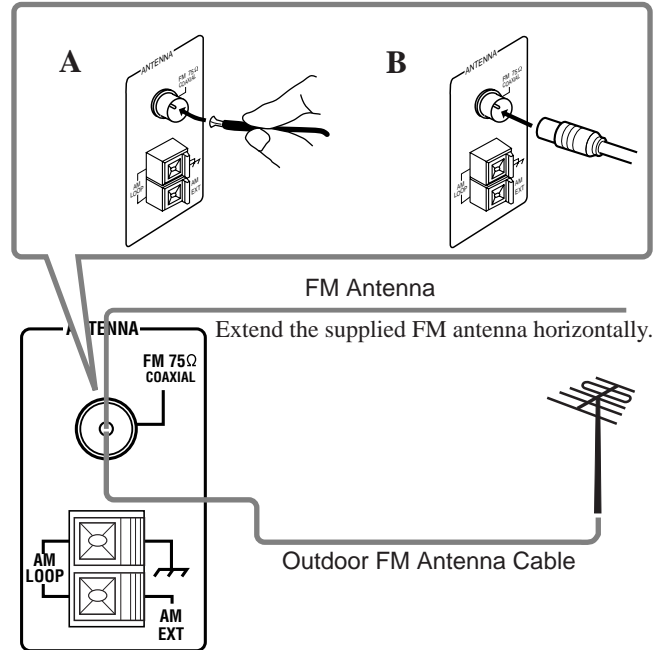

A. Using the Supplied FM Antenna

The FM antenna provided can be connected to the FM 75 Ω COAXIAL terminal as temporary measure.

B. Using the Standard Type Connector (Not Supplied)

A standard type connector should be connected to the FM 75 Ω COAXIAL terminal.

Note:

If reception is poor, connect an outdoor antenna. Before attaching a 75 Ω coaxial cable (the kind with a round wire going to an outdoor antenna), disconnect the supplied FM antenna.

AM Antenna Connections

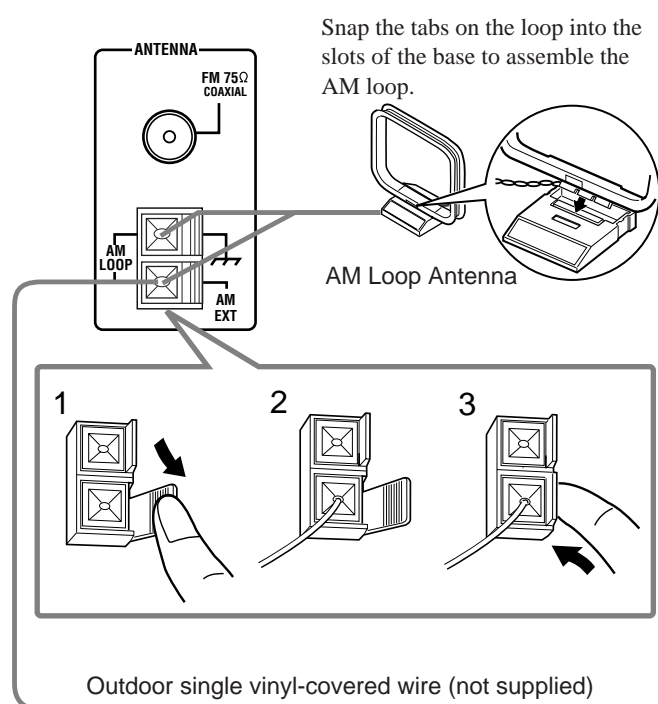

Turn the loop until you have the best reception.

Notes:

- If the AM loop antenna wire is covered with vinyl, remove the vinyl by twisting it as shown in the diagram.
- Make sure the antenna conductors do not touch any other terminals, connecting cords and power cord. This could cause poor reception.
- If reception is poor, connect an outdoor single vinyl-covered wire to the AM EXT terminal. (Keep the AM loop antenna connected.)



Connecting the Speakers

You can connect the following speakers:

- One pair of front speakers to produce normal stereo sound.
- One pair of rear speakers to enjoy the surround effect.
- One center speaker to produce more effective surround effect (to emphasize human voices).
- One subwoofer to enhance the bass.

IMPORTANT:

After connecting the speakers listed above, set the speaker setting information properly to obtain the best possible DSP effect. For details, see page 12.

For each speaker (except for a subwoofer), connect the (+) and (-) terminals on the rear panel to the (+) and (-) terminals marked on the speakers. For connecting a subwoofer, see page 5.

CAUTION:

Use speakers with the SPEAKER IMPEDANCE indicated by the speaker terminals.

Basic connecting procedure

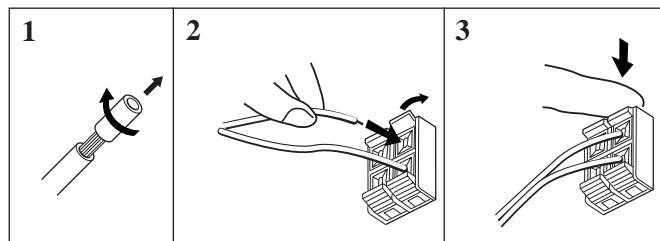

- 1 Cut, twist and remove the insulation at the end of each speaker signal cable (not supplied).
- 2 Open the terminal and then insert the speaker signal cable.
- 3 Close the terminal.

Connecting the front speakers

Connect front speakers to the FRONT SPEAKERS terminals.

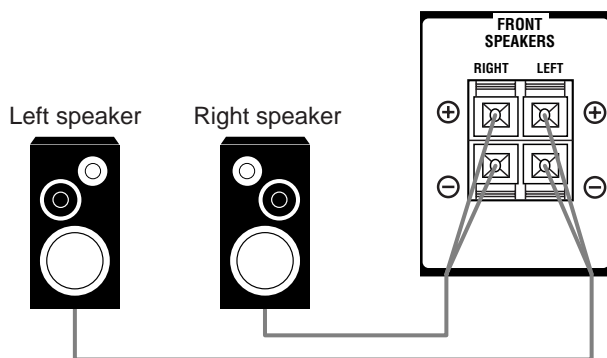

Connecting the rear and center speakers

Connect rear speakers to the REAR SPEAKERS terminals and a center speaker to the CENTER SPEAKER terminals.

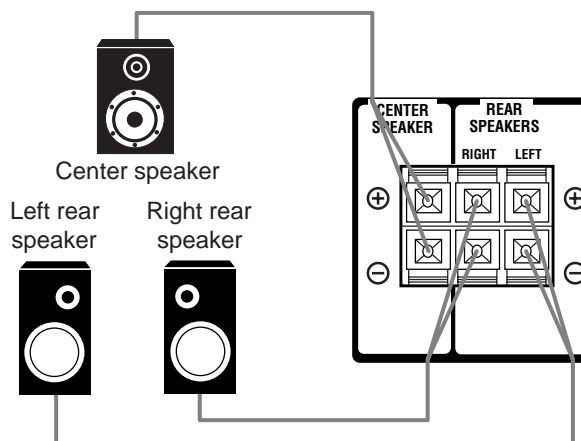

Connecting the subwoofer speaker

You can enhance the bass by connecting a subwoofer. Connect the input jack of a powered subwoofer to the SUBWOOFER OUT jack on the rear panel, using a cable with RCA pin plugs (not supplied).



Connecting Audio/Video Components

You can connect the following audio/video components to this receiver. Refer also to the manuals supplied with your components.

Audio Components	Video Components
• CD player*	• DVD player*
• Cassette deck or CD recorder*	• TV*
	• VCR

* You can connect these components using the methods described in "Analog connections" (below) or in "Digital connections" (see page 7).

Analog connections

Audio component connections

Use the cables with RCA pin plugs (not supplied). Connect the white plug to the audio left jack, and the red plug to the audio right jack.

CAUTION:

If you connect a sound-enhancing device such as a graphic equalizer between the source components and this receiver, the sound output through this receiver may be distorted.

Cassette deck or CD recorder

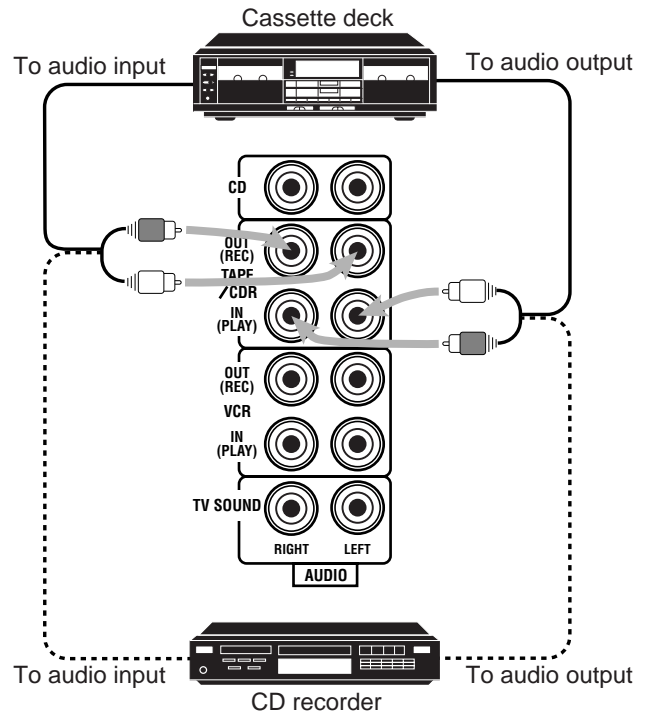

Note:

You can connect either a cassette deck or a CD recorder to the TAPE/CDR jacks. When connecting a CD recorder to the TAPE/CDR jacks, change the source name, which will be shown on the display when selected as the source, to "CDR." See page 11 for details.

If your audio components have a COMPU LINK jack

See also page 25 for detailed information about the connection and the COMPU LINK remote control system.

CD player

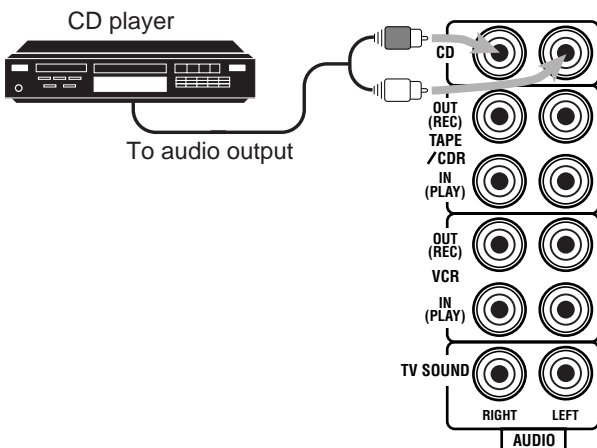

Video component connections

Use the cables with RCA pin plugs (not supplied).
 Connect the white plug to the audio left jack, the red plug to the audio right jack, and the yellow plug to the video jack.

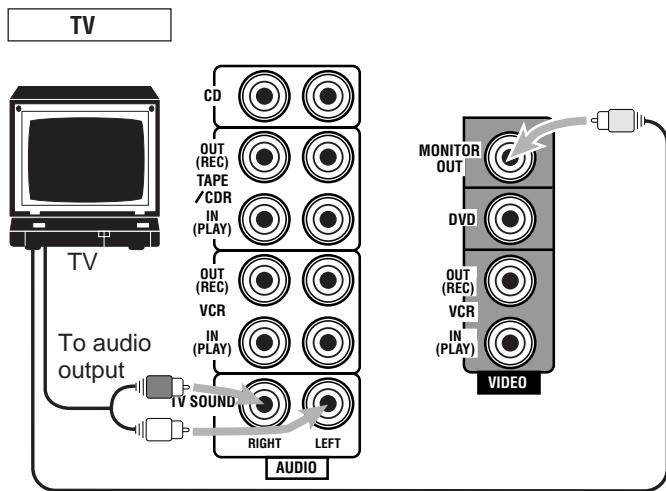

To video input

Connect the TV to the MONITOR OUT jack to view the playback picture from the other connected video components.

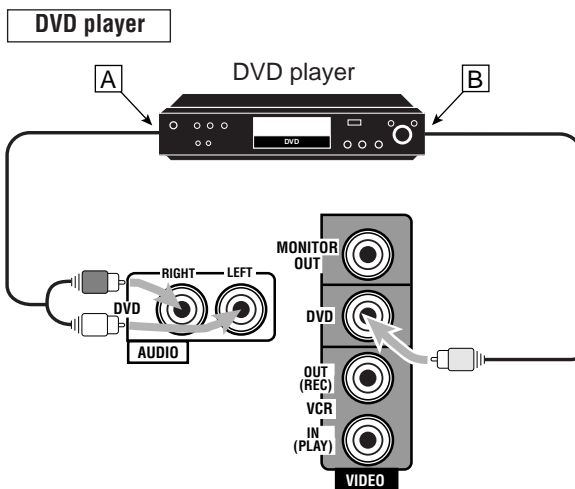

- A To front left/right channel audio output (or to audio mixed output if necessary)
- B To video output

Note:

To enjoy the software encoded with Dolby Digital or DTS Digital Surround, you must connect the DVD player using the digital terminal on the rear of this receiver. (See "Digital connections" on page 7.)

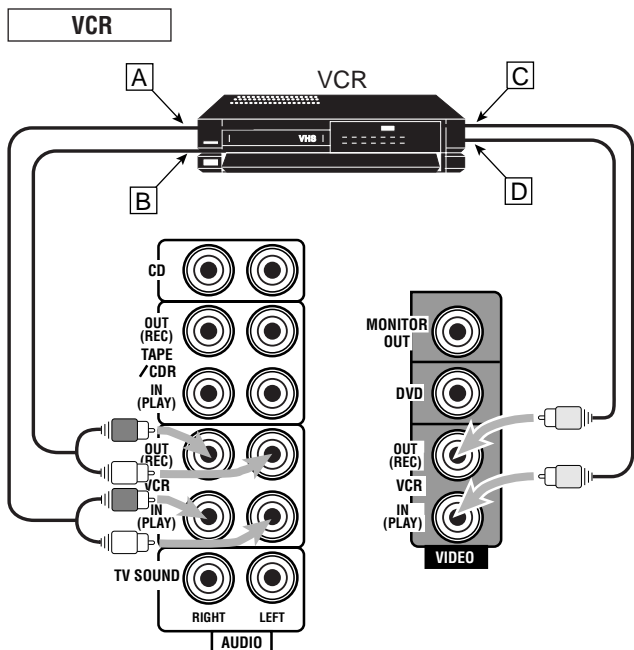

- A To left/right channel audio output
- B To left/right channel audio input
- C To video output
- D To video input

Digital connections

This receiver is equipped with two DIGITAL IN terminals — one digital coaxial terminal and one digital optical terminal. You can connect any component to one of the digital terminals using a digital coaxial cable (not supplied) or digital optical cable (not supplied).

IMPORTANT:

- When connecting the DVD player or digital TV broadcast tuner using the digital terminal, you also need to connect it to the video jack on the rear. Without connecting it to the video jack, you can view no playback picture.
- After connecting the components using the DIGITAL IN terminals, set the following correctly if necessary.
 - Set the digital input (DIGITAL IN) terminal setting correctly. For details, see “Digital Input (DIGITAL IN) Terminal Setting” on page 14.
 - Select the digital input mode correctly. For details, see “Selecting the Analog or Digital Input Mode” on page 14.

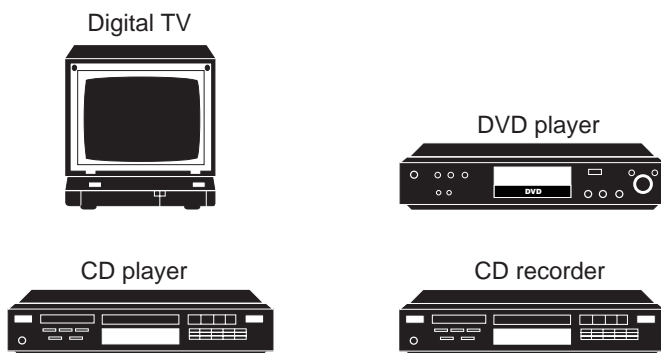

When the component has a digital coaxial output terminal, connect it to the DIGITAL 1 (DVD) terminal, using the digital coaxial cable (not supplied).

When the component has a digital optical output terminal, connect it to the DIGITAL 2 (CD) terminal, using the digital optical cable (not supplied).

Before connecting a digital optical cable, unplug the protective plug.

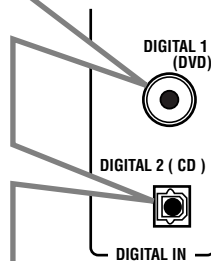
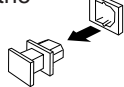

Notes:

- When shipped from the factory, the DIGITAL IN terminals have been set for use with the following components.
 - DIGITAL 1 (coaxial): For DVD player
 - DIGITAL 2 (optical): For CD player
- When you want to operate the CD player or CD recorder using the COMPU LINK remote control system, connect the target component also as described in “Analog connections” (see page 5).

Connecting the Power Cord

Before plugging the receiver into an AC outlet, make sure that all connections have been made.

Plug the power cord into an AC outlet.

Keep the power cord away from the connecting cables and the antenna. The power cord may cause noise or screen interference. We recommend that you use a coaxial cable to connect the antenna, since it is well-shielded against interference.

Notes:

- The preset settings such as preset channels and sound adjustment may be erased in a few days in the following cases:
 - When you unplug the power cord.
 - When a power failure occurs.
- If the wall outlet does not match the AC plug, use the supplied AC plug adaptor.

CAUTIONS:

- Do not plug in before setting the voltage selector switch on the rear of the unit and all connection procedures are complete.
- Do not touch the power cord with wet hands.
- Do not pull on the power cord to unplug the cord. When unplugging the cord, always grasp the plug so as not to damage the cord.

Putting Batteries in the Remote Control

Before using the remote control, put two supplied batteries first. When using the remote control, aim the remote control directly at the remote sensor on the receiver.

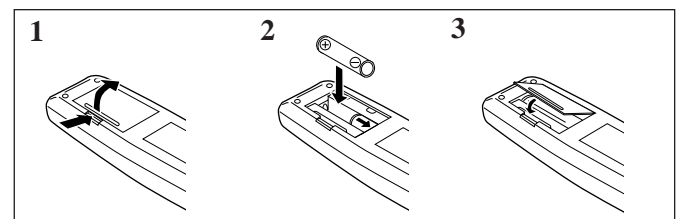

1. On the back of the remote control, remove the battery cover.
2. Insert batteries. Make sure to match the polarity: (+) to (+) and (-) to (-).
3. Replace the cover.

If the range or effectiveness of the remote control decreases, replace the batteries. Use two R6P(SUM-3)/AA(15F) type dry-cell batteries.

CAUTION:

Follow these precautions to avoid leaking or cracking cells:

- Place batteries in the remote control so they match the polarity: (+) to (+) and (-) to (-).
- Use the correct type of batteries. Batteries that look similar may differ in voltage.
- Always replace both batteries at the same time.
- Do not expose batteries to heat or flame.

Basic Operations

The following operations are commonly used when you play any sound source.

Turning the Power On and Off (Standby)

On the front panel:

To turn on the power, press STANDBY/ON .

The STANDBY lamp goes off. The name of the current source (or station frequency) appears on the display.

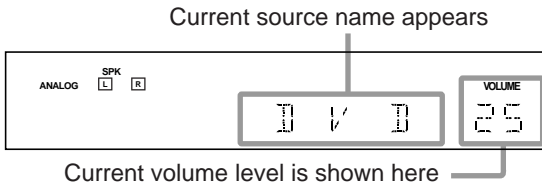
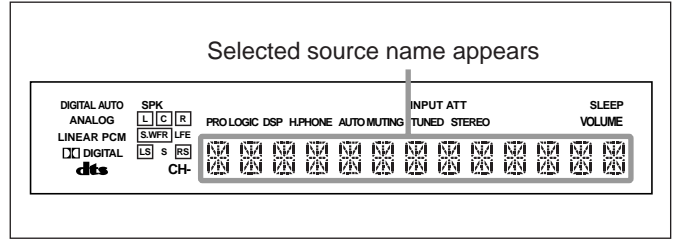
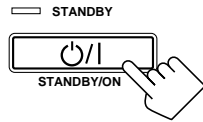

To turn off the power (into standby mode), press STANDBY/ON  again.

The STANDBY lamp lights up. A small amount of power is consumed in standby mode. To turn the power off completely, unplug the AC power cord.

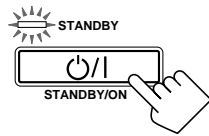

From the remote control:

To turn on the power, press AUDIO in the  (standby/on) section.

The STANDBY lamp goes off. The name of the current source (or station frequency) appears on the display.



To turn off the power (into standby mode), press AUDIO in the  (standby/on) section again.

The STANDBY lamp lights up.

Selecting the Source to Play

Press one of the source selecting buttons.

On the front panel:

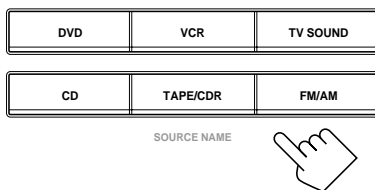

From the remote control:

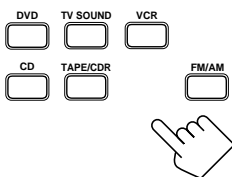

- DVD Select the DVD player.
- TV SOUND Select the TV sound.
- VCR Select the video component connected to the VCR jacks.
- CD * Select the CD player.
- TAPE/CDR * Select the cassette deck (or the CD recorder).
- FM/AM * Select an FM or AM broadcast.
 - Each time you press the button, the band alternates between FM and AM.

Notes:

- When connecting a CD recorder (to the TAPE/CDR jacks), change the source name that appears on the display. See page 11 for details.
- When you have connected some digital source components using the digital terminals (see page 7), you need to select the digital input mode.
- When you press one of the source selecting buttons on the remote control marked above with an asterisk (*), the receiver automatically turns on.

Signal and speaker indicators on the display

The signal indicators light up in the following cases:

- Only the indicators for the incoming signals light up.
- When analog input is selected, "L" and "R" always light up.

The speaker indicators light up only —:

- When the corresponding speaker is activated.
- AND
- When the corresponding speaker is required for the DSP mode selected currently.

Signal indicators light up in red:	Speaker indicators light up in white:

- L:
 - When digital input is selected: Lights up when the left channel signal comes in.
 - When analog input is selected: Always lights up.
- R:
 - When digital input is selected: Lights up when the right channel signal comes in.
 - When analog input is selected: Always lights up.
- C: Lights up when the center channel signal comes in.
- LS: Lights up when the left rear channel signal comes in.
- RS: Lights up when the right rear channel signal comes in.
- S: Lights up when the monaural rear channel signal comes in.
- LFE: Lights up when the LFE channel signal comes in.

Note:

When "SUBWOOFER" is set to "YES" (see page 11),  lights up.

Selecting different sources for picture and sound

You can watch picture from a video component while listening to sound from another component. Press one of the audio source selecting buttons (CD, TAPE/CDR, FM/AM), while viewing the picture from a video component such as the VCR or DVD player, etc.

On the front panel:

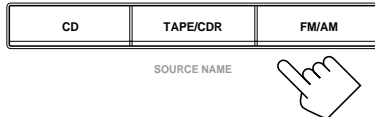

From the remote control:

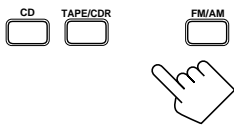

Adjusting the Volume

On the front panel:

To increase the volume, turn MASTER VOLUME clockwise.

To decrease the volume, turn it counterclockwise.

- When you turn MASTER VOLUME rapidly, the volume level also changes rapidly.
- When you turn MASTER VOLUME slowly, the volume level also changes slowly.

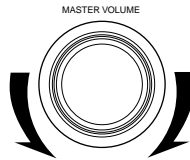

From the remote control:

To increase the volume, press VOLUME +.

To decrease the volume, press VOLUME -.

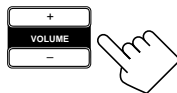

CAUTION:

Always set the volume to the minimum before starting any source. If the volume is set at its high level, the sudden blast of sound energy can permanently damage your hearing and/or ruin your speakers.

Note:

The volume level can be adjusted within the range of "0" (minimum) to "80" (maximum).

Listening Only with Headphones

You must turn off speakers when you listen with headphones.

1. Connect a pair of headphones to the PHONES jack on the front panel.
2. Press SPEAKERS ON/OFF so that the SPK indicator disappears from the display. This cancels the DSP mode currently selected, and activates the HEADPHONE mode (see below).
 - "HEADPHONE" appears and H. PHONE indicator lights up on the display.

HEADPHONE mode:

This mode can reproduce the LFE channel signals, mixing them with the front channel signals. So you will not miss the subwoofer sounds even if you listen to a source using the headphones.

Notes:

- While in the HEADPHONE mode, you cannot use any DSP modes (see page 18.)
- Activating the speaker cancels the HEADPHONE mode and turns on the DSP mode previously selected.

CAUTION:

Be sure to turn down the volume before connecting or putting on headphones, as high volume can damage both the headphones and your hearing.

Muting the Sound

From the remote control ONLY:

Press MUTING to mute the sound through all speakers and headphones connected.

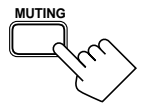

"MUTING" appears on the display and the volume turns off (the volume level indicator goes off).

To restore the sound, press MUTING again so that "OFF" appears on the display.

- Turning MASTER VOLUME on the front panel or pressing VOLUME +/- on the remote control also restores the sound.

Adjusting the Subwoofer Output Level

You can adjust the subwoofer output level if you have selected "YES" for the "SUBWOOFER" (see page 11). Once it has been adjusted, the receiver memorizes the adjustment.

Before you start, remember...

- There is a time limit in doing the following steps. If the setting is canceled before you finish, start from step 1 again.
- When the front speakers are deactivated, the subwoofer level cannot be adjusted.

On the front panel:

1. Press **ADJUST** repeatedly until "SUBWFR LEVEL" appears on the display.

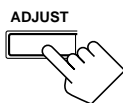

The display changes to show the current setting.

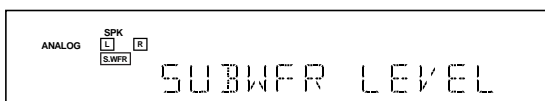

2. Press **CONTROL UP ▲/DOWN ▼** to adjust the subwoofer output level (+10 dB to -10 dB).

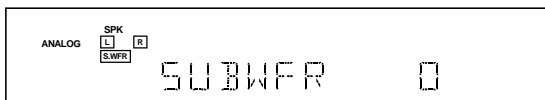
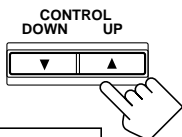

From the remote control:

1. Press **SOUND**.

The 10 keys are activated for sound adjustments.

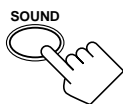

2. Press **SUBWOOFER +/-** to adjust the subwoofer output level (+10 dB to -10 dB).

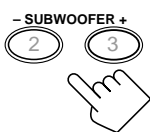

Attenuating the Input Signal

When the input level of the playing source is too high, the sounds will be distorted. If this happens, you need to attenuate the input signal level to prevent the sound distortion. Once it has been adjusted, the receiver memorizes the adjustment.

On the front panel ONLY:

Press and hold **INPUT ATT** so that the **INPUT ATT** indicator lights up on the display.

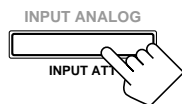

- Each time you press and hold the button, the Input Attenuator mode turns on ("INPUT ATT ON") or off ("INPUT NORMAL").

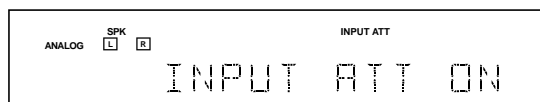

Notes:

- This function is available only for the sources connected using the analog terminals.
- This function does not take effect when digital input is selected.

Adjusting the Tone

You can adjust the bass and treble sounds as you like. Once it has been adjusted, the receiver memorizes the adjustment.

Before you start, remember...

- There is a time limit in doing the following steps. If the setting is canceled before you finish, start from step 1 again.

On the front panel ONLY:

1. Press **ADJUST** repeatedly until "BASS" or "TREBLE" appears on the display.

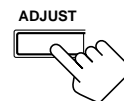

- Select "BASS" to adjust the bass sound level.
- Select "TREBLE" to adjust the treble sound level.

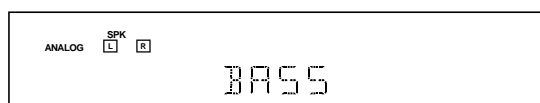

or



2. Press **CONTROL UP ▲/DOWN ▼** to adjust the bass or treble sound level (+10 dB to -10 dB).

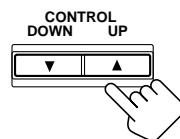

- Each time you press the button, the sound level changes by ± 2 steps.

Basic Settings

Some of the following settings are required after connecting and positioning your speakers in your listening room, while others will make operations easier.

Recording a Source

You can record any source playing through the receiver to a cassette deck (or a CD recorder) connected to the TAPE/CDR jacks and the VCR connected to the VCR jacks at the same time.

While recording, you can listen to the selected sound source at whatever sound level you like without affecting the sound levels of the recording.

Note:

The output volume level, tone adjustment (see page 10), and DSP modes (see page 18) cannot affect the recording.

Adjusting the Front Speaker Output Balance

If the sounds you hear from the front right and left speakers are unequal, you can adjust the speaker output balance. Once it has been adjusted, the receiver memorizes the adjustment.

Before you start, remember...

- There is a time limit in doing the following steps. If the setting is canceled before you finish, start from step 1 again.

On the front panel ONLY:

1. Press **ADJUST** repeatedly until “L/R BALANCE” appears on the display.

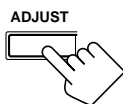

The display changes to show the current setting.

2. Press **CONTROL UP ▲/DOWN ▼** to adjust the balance.

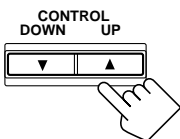

- Pressing **CONTROL UP ▲** decreases the left channel output from CNTR (Center) to -21.
- Pressing **CONTROL DOWN ▼** decreases the right channel output from CNTR (Center) to -21.

Setting the Subwoofer Information

Register whether you have connected a subwoofer or not.

Before you start, remember...

- There is a time limit in doing the following steps. If the setting is canceled before you finish, start from step 1 again.

On the front panel ONLY:

1. Press **SETTING** repeatedly until “SUBWOOFER” appears on the display.

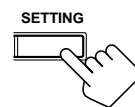

The display changes to show the current setting.

2. Press **CONTROL UP ▲/DOWN ▼** to register whether you have connected a subwoofer or not.

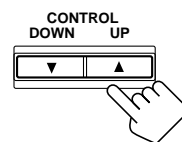

- Each time you press the button, the subwoofer setting alternates between “YES” and “NO.”

YES: Select this when a subwoofer is used. **[S.WFR]** lights up on the display (see page 8.)

NO: Select this when no subwoofer is used.

Changing the Source Name

When you have connected the CD recorder to the TAPE/CDR jacks on the rear panel, change the source name shown on the display when you select the CD recorder as the source.

On the front panel ONLY:

When changing the source name from “TAPE” to “CDR”:

1. Press **TAPE/CDR**.
 - Make sure “TAPE” appears on the display.
2. Press and hold **SOURCE NAME (TAPE/CDR)** until “ASSGN. CDR” appears on the display.

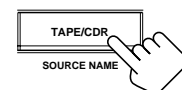

To change the source name from “CDR” to “TAPE,” repeat the same procedure above (in step 1, make sure “CDR” appears on the display).

Note:

Without changing the source name, you can still use the connected components. However, there may be some inconvenience.

- “TAPE” will appear on the display when you select the CD recorder.
- You cannot use the digital input (see page 14) for the CD recorder.
- You cannot use the COMPU LINK remote control system (see page 25) to operate the CD recorder.

Setting the Speakers for the DSP Modes

To obtain the best possible surround sound of the DSP (Digital Signal Processor) modes (see page 18), you have to register the information about the speakers arrangement after all connections are completed.

Before you start, remember...

- There is a time limit in doing the following steps. If the setting is canceled before you finish, start from step 1 again.

Front, Center, and Rear Speaker Setting

Register the sizes of all the connected speakers.

- When you change your speakers, you need to register the information about the speakers again.

On the front panel ONLY:

1. Press **SETTING** repeatedly until “**FRONT SPK**” (Front Speaker), “**CENTER SPK**” (Center Speaker), or “**REAR SPK**” (Rear Speaker) appears on the display.

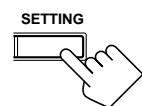

The display changes to show the current setting.

2. Press **CONTROL UP ▲/DOWN ▼** to select the appropriate item about the speaker selected in the above step.

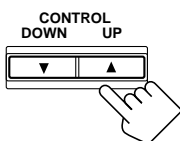

- Each time you press the button, the display changes to show the following:

LARGE ↔ SMALL ↔ NO

LARGE: Select this when the speaker size is relatively large.

SMALL: Select this when the speaker size is relatively small.

NO: Select this when you have not connected a speaker.
(Not selectable for the front speakers)

3. Repeat steps 1 and 2 to select the appropriate items for the other speakers.

Notes:

- Keep the following comment in mind as reference when adjusting.
 - If the size of the cone speaker unit built in your speaker is greater than 12 cm, select “LARGE,” and if it is smaller than 12 cm, select “SMALL.”
- If you have selected “NO” for the subwoofer setting, you can only select “LARGE” for the front speaker setting.
- If you have selected “SMALL” for the front speaker setting, you cannot select “LARGE” for the center and rear speaker settings.

Center Delay Time Setting

Register the delay time of the sound from the center speaker, comparing to that of the sound from the front speakers.

If the distance from your listening point to the center speaker is equal to that to the front speakers, select 0 msec. As the distance to the center speaker becomes shorter, the delay time increases .

- 1 msec increase (or decrease) in delay time corresponds to 30 cm decrease (or increase) in distance.
- When shipped from the factory, delay time is set to 0 msec.

On the front panel ONLY:

1. Press **SETTING** repeatedly until “**CENTER DELAY**” appears on the display.

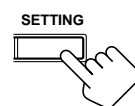

The display changes to show the current setting.

2. Press **CONTROL UP ▲/DOWN ▼** to select the delay time of the center speaker output.

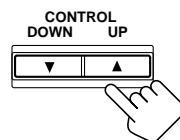

- Pressing **CONTROL UP ▲** increases the delay time from 0 msec (“C_DELAY 0MS”) to 5 msec (“C_DELAY 5MS”).
- Pressing **CONTROL DOWN ▼** decreases the delay time from 5 msec (“C_DELAY 5MS”) to 0 msec (“C_DELAY 0MS”).

Note:

You cannot adjust the center delay time when you have set “CENTER SPK” to “NO.”

Rear Delay Time Setting

Register the delay time of the sound from the rear speakers, comparing to that of the sound from the front speakers.

If the distance from your listening point to the rear speakers is equal to that to the front speakers, select 0 msec. As the distance to the rear speakers becomes shorter, the delay time increases.

- 1 msec increase (or decrease) in delay time corresponds to 30 cm decrease (or increase) in distance.
- Rear delay time for Dolby Digital and DTS Digital Surround is to be set to 5 msec.
- When shipped from the factory, delay time is set to 5 msec.

On the front panel ONLY:

1. Press **SETTING** repeatedly until “**REAR DELAY**” appears on the display.

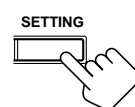

The display changes to show the current setting.

2. Press **CONTROL UP ▲/DOWN ▼** to select the delay time of the rear speaker output.

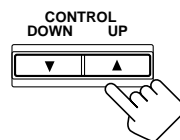

- Pressing **CONTROL UP ▲** increases the delay time from 0 msec (“R_DELAY 0MS”) to 15 msec (“R_DELAY 15MS”).
- Pressing **CONTROL DOWN ▼** decreases the delay time from 15 msec (“R_DELAY 15MS”) to 0 msec (“R_DELAY 0MS”).

Note:

You cannot adjust the rear delay time when you have set “REAR SPK” to “NO.”

Crossover Frequency Setting

Small speakers cannot reproduce the bass sound very well. So, if you have used a small speaker for any of the front, center, and rear channels, this receiver automatically reallocates the bass elements, originally assigned to the channel for which you have connected the small speaker, to another channel (for which you have connected the large speaker).

If you have selected "LARGE" for all speakers (see page 12), this function will not take effect. To use this function properly, you need to set this crossover frequency level according to the size of the small speaker connected.

On the front panel ONLY:

1. Press **SETTING** repeatedly until "**CROSSOVER FRQ**" (Crossover Frequency) appears on the display.

The display changes to show the current setting.

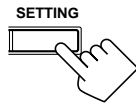

2. Press **CONTROL UP ▲/DOWN ▼** to select the crossover frequency level according to the size of the small speaker connected.

• Each time you press the button, the display changes to show the following:

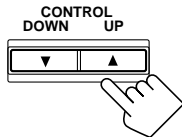

→ 80HZ ↔ 100HZ ↔ 120HZ ←

- Use the following comments as reference when adjusting.

80HZ:	Select this when the cone speaker unit built in the speaker is about 12 cm.
100HZ:	Select this when the cone speaker unit built in the speaker is about 10 cm.
120HZ:	Select this when the cone speaker unit built in the speaker is about 8 cm.

Note:

Crossover frequency is not valid for the HEADPHONE mode.

Low Frequency Effect Attenuator Setting

If the bass sound is distorted while playing back a source using Dolby Digital or DTS Digital Surround, follow the procedure below.

On the front panel ONLY:

1. Press **SETTING** repeatedly until "**LFE ATT**" (Low Frequency Effect Attenuator) appears on the display.

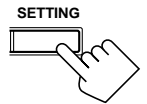

The display changes to show the current setting.

2. Press **CONTROL UP ▲/DOWN ▼** to select the low frequency effect attenuator level.

• Each time you press the button, the display changes to show the following:

0dB ↔ 10dB

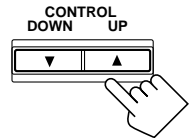

0dB: Normally select this.

10dB: Select this when the bass sound is distorted.

Note:

This function takes effect only when the subwoofer (LFE) signals come in, (with "SUBWOOFER" set to "YES.")

Dynamic Range Compression Setting

You can compress the dynamic range (difference between maximum sound and minimum sound) of the reproduced sound. This is useful when enjoying surround sound at night.

- This function takes effect only when playing back a source using Dolby Digital.

On the front panel ONLY:

1. Press **SETTING** repeatedly until "**D_RANGE COMP**" (Dynamic Range Compression) appears on the display.

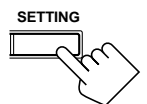

The display changes to show the current setting.

2. Press **CONTROL UP ▲/DOWN ▼** to select the appropriate item about the compression level.

• Each time you press the button, the display changes to show the following:

→ OFF ↔ MID ↔ MAX ←

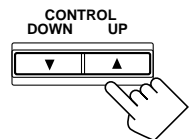

OFF: Select this when you want to enjoy surround with its full dynamic range. (No effect applied.)

MID: Select this when you want to reduce the dynamic range a little. (Factory setting.)

MAX: Select this when you want to apply the compression effect fully. (Useful at night.)

Note:

Dynamic Range Compression is not valid for the DTS Digital Surround.

Digital Input (DIGITAL IN) Terminal Setting

When you use the digital input terminals, you have to register what components are connected to which terminals (DIGITAL IN 1/2).

Before you start, remember...

- There is a time limit in doing the following steps. If the setting is canceled before you finish, start from step 1 again.

On the front panel ONLY:

1. Press **SETTING** repeatedly until "DIGITAL IN" appears on the display.

The display changes to show the current setting.

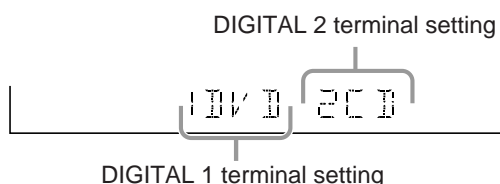

2. Press **CONTROL UP ▲/DOWN ▼** to select the appropriate digital terminal setting.

- Each time you press the button, the display changes to show the following:

1 DVD 2 CD	⇌	1 DVD 2 TV	⇌	1 DVD 2 CDR	⇌
1 CD 2 DVD	⇌	1 CD 2 TV	⇌	1 CD 2 CDR	⇌
1 TV 2 DVD	⇌	1 TV 2 CD	⇌	1 TV 2 CDR	⇌
1 CDR 2 DVD	⇌	1 CDR 2 CD	⇌	1 CDR 2 TV	⇌

(back to the beginning)

Note:

When shipped from the factory, the DIGITAL IN terminals can be used as the digital input for the following components.

- DIGITAL 1 (coaxial): For DVD player
- DIGITAL 2 (optical): For CD player

Selecting the Analog or Digital Input Mode

When you have connected digital source components using both the analog connection (see page 5) and the digital connection methods (see page 7), you need to select the input mode correctly.

On the front panel :

1. Press one of the source selecting buttons (DVD, TV SOUND, CD, or TAPE/CDR)* for which you want to change the input mode.

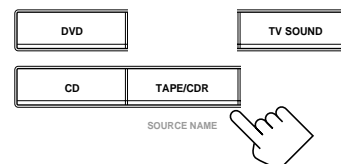

Note:

* Among the sources listed above, you can select the digital input only for the sources which you have selected the digital input terminals for. (See "Digital Input (DIGITAL IN) Terminal Setting.")

2. Press **INPUT DIGITAL** to select the digital input mode (AUTO).

The DIGITAL AUTO indicator lights up on the display, and the digital signal indicator for the detected signals also light up.*

- When "AUTO" is selected, the receiver automatically detects the incoming signal format.

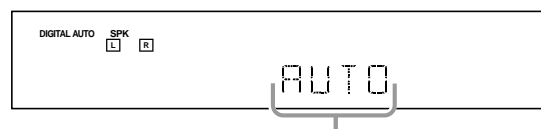

"AUTO" appears for about 4 seconds.

* The followings are the analog/digital signal indicators on the display to indicate what type of the signal comes into the receiver.

- DIGITAL AUTO** : Lights up when "AUTO" is selected as the digital input mode.
- ANALOG** : Lights up when the analog input is selected.
- LINEAR PCM** : Lights up when Linear PCM signals come in.
- DIGITAL** : Lights up when Dolby Digital signals come in.
- dts** : Lights up when DTS Digital Surround signals come in.

Continued to the next page.

When playing a software encoded with the DTS Digital Surround, "AUTO" may not work properly and the following symptoms may occur:

- Sound does not come out at the beginning of playback.
- Noise comes out while using the searching or skipping function.

In this case, press CONTROL UP ▲/DOWN ▼ to select "DTS" while "AUTO" is lit on the display.

- Each time you press the button, the input mode changes as follows:

AUTO ←→ DTS
(Digital) (Digital)

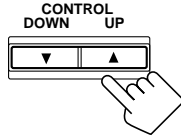

The DIGITAL AUTO indicator does not light up on the display while "DTS" is selected.

To change the input mode back to "AUTO," press CONTROL UP ▲/DOWN ▼ while "DTS" is lit on the display after pressing INPUT DIGITAL.

If **dts** flashes while "DTS" is selected as the input mode, select "AUTO."

Note:

When you turn off the power or select another source, "DTS" setting is canceled and the digital input mode is automatically reset to "AUTO."

To change the input mode back to analog input, press INPUT ANALOG.

"ANALOG" appears on the display for a while.

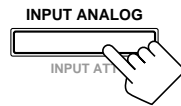

From the remote control:

1. Press the source selecting button (DVD, TV SOUND, CD, or TAPE/CDR)* for which you want to change the input mode.

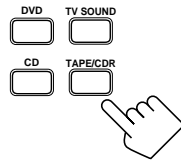

Note:

* Among the sources listed above, you can select the digital input only for the sources which you have selected the digital input terminals for. (See "Digital Input (DIGITAL IN) Terminal Setting.")

2. Press ANALOG/DIGITAL to change the input mode.

- Each time you press the button, the input mode changes as follows:

ANALOG ←→ AUTO
(Digital)



When playing a software encoded with the DTS Digital Surround, "AUTO" may not work properly. In this case, press CONTROL UP ▲/DOWN ▼ on the front panel to select "DTS." (See above.)

Note:

You can only select "ANALOG" and "AUTO" using the remote control.

Storing the Basic Settings and Adjustments

You can assign and store different sound settings for each different playing source. By using this function, you do not have to change the settings every time you change the source. The stored settings for the newly selected source are automatically recalled.

The following can be stored for each source:

- Subwoofer output level (see page 10)
- Input attenuator mode (see page 10)
- Tone adjustment (see page 10)
- Balance (see page 11)
- DSP modes
 - Surround mode (see page 21)
 - DAP mode (see page 23)

The above settings are stored automatically in the following cases:

- When you turn on the power.
- When you change the source.
- When you assign the source name.

Notes:

- You cannot assign and store different settings for digital input mode and analog input mode.
- If the source is FM or AM, you can assign a different setting for each band.

Using the Sleep Timer

Using the Sleep Timer, you can fall asleep to music and know the receiver will turn off by itself rather than play all night.

From the remote control ONLY:

Press SLEEP repeatedly.

The SLEEP indicator lights up on the display, and the shut-off time changes as follows (in minutes):

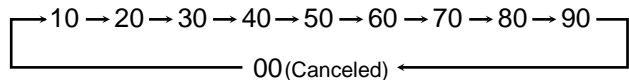

When the shut-off time comes

The receiver turns off automatically.

To check or change the time remaining until the shut-off time

Press SLEEP once.

The remaining time until the shut-off time appears in minutes.

- To change the shut-off time, press SLEEP repeatedly.

To cancel the Sleep Timer

Press SLEEP repeatedly until "SLEEP 00 MIN." appears on the display. (The SLEEP indicator goes off.)

- Turning off the power also cancels the Sleep Timer.

Receiving Radio Broadcasts

You can browse through all the stations or use the preset function to go immediately to a particular station.

Setting the AM Tuner Interval Spacing

Some countries space AM stations 9 kHz apart, and other countries use 10 kHz spacing.

On the front panel ONLY:

To select the 10 kHz interval:

Be sure the receiver is turned off, but is plugged into an AC outlet. Hold down FM/AM TUNING ▲ and press STANDBY/ON ⏻. Now the 10 kHz interval is selected.

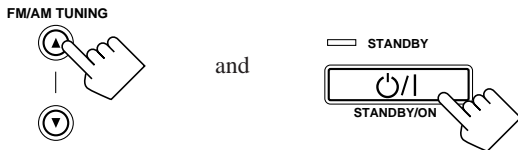

To change back to the 9 kHz interval:

Be sure the receiver is turned off, but is plugged into an AC outlet. Hold down FM/AM TUNING ▼ and press STANDBY/ON ⏻. Now the 9 kHz interval is selected.

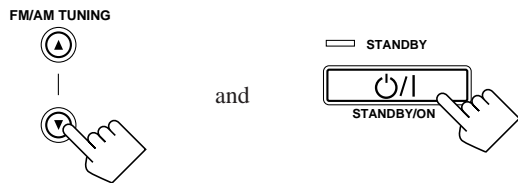

Tuning in Stations Manually

On the front panel ONLY:

1. Press FM/AM to select the band (FM or AM).

- Each time you press the button, the band alternates between FM and AM.

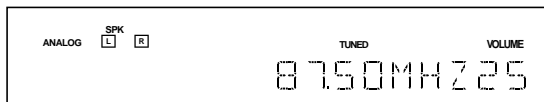
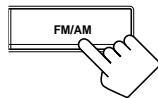

2. Press FM/AM TUNING ▲/▼ until you find the frequency you want.

- Pressing FM/AM TUNING ▲ increases the frequency.
- Pressing FM/AM TUNING ▼ decreases the frequency.

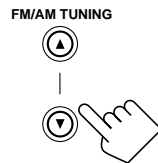

Notes:

- When you hold FM/AM TUNING ▲/▼ in step 2, the frequency keeps changing until a station is tuned in.
- When a station of sufficient signal strength is tuned in, the TUNED indicator lights up on the display.
- When an FM stereo program is received, the STEREO indicator also lights up.

Using Preset Tuning

Once a station is assigned to a channel number, the station can be quickly tuned. You can preset up to 30 FM and 15 AM stations.

To store the preset stations

Before you start, remember...

- There is a time limit in doing the following steps. If the setting is canceled before you finish, start from step 1 again.

On the front panel ONLY:

1. Tune in the station you want to preset (see “Tuning in Stations Manually”).

If you want to store the FM reception mode for this station, select the FM reception mode you want. See “Selecting the FM Reception Mode” on page 17.

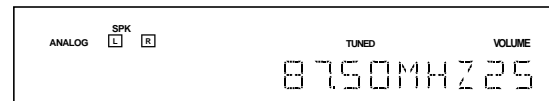

2. Press MEMORY.



“CH-” appears and the channel number position starts flashing on the display for about 5 seconds.

3. Press FM/AM PRESET ▲/▼ to select a channel number while the channel number position is flashing.



Note:

You can use the 10 keys on the remote control to select the preset number. When using the 10 keys, be sure that they are activated for the tuner, not for the CD and others. (See page 26.)

4. Press MEMORY again while the selected channel number is flashing on the display.

The selected channel number stops flashing. The station is assigned to the selected channel number.

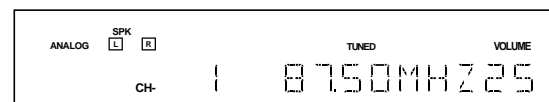

5. Repeat steps 1 to 4 until you store all the stations you want.

To erase a stored preset station

Storing a new station on a used number erases the previously stored one.

To tune in a preset station

On the front panel:

1. Press FM/AM to select the band (FM or AM).

The last received station of the selected band is tuned in.

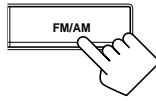

2. Press FM/AM PRESET ▲/▼ until you find the channel you want.

- Pressing FM/AM PRESET ▲ increases the channel numbers.
- Pressing FM/AM PRESET ▼ decreases the channel numbers.

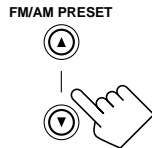

From the remote control:

1. Press FM/AM.

- Each time you press the button, the band alternates between FM and AM.

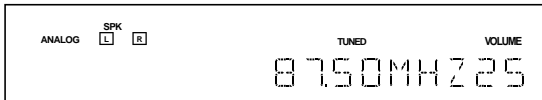
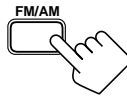

2. Press 10 keys to select a preset channel number.

- For channel number 5, press 5.
- For channel number 15, press +10 then 5.
- For channel number 20, press +10 then 10.
- For channel number 30, press +10, +10, then 10.

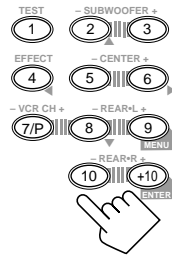

Note:

When you use the 10 keys on the remote control, be sure that they are activated for the tuner, not for the CD and others. (See page 26.)

Selecting the FM Reception Mode

When an FM stereo broadcast is hard to receive or noisy

You can change the FM reception mode while receiving an FM broadcast.

- You can store the FM reception mode for each preset station.

On the front panel ONLY:

Press FM MODE.

- Each time you press the button, the FM reception mode alternates between "AUTO" and "MONO."

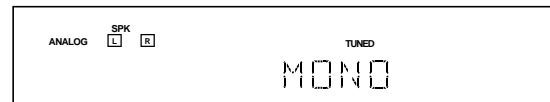
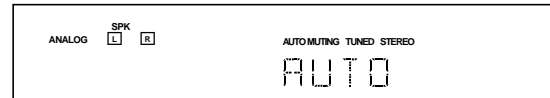

AUTO:

When a program is broadcasted in stereo, you will hear stereo sound; when in monaural, you will hear monaural sounds. This mode is also useful to suppress static noise between stations. The AUTO MUTING indicator lights up on the display.

MONO:

Reception will be improved although you will lose the stereo effect. In this mode, you will hear noise while tuning into the stations. The AUTO MUTING indicator goes off from the display.

Using the DSP Modes

The built-in Surround Processor provides two types of the DSP (Digital Signal Processor) mode — Surround mode and DAP (Digital Acoustic Processor) mode.

What are the DSP Modes?

Surround modes

With this receiver, you can use three types of the Surround mode. **Following modes cannot be used when only the front speakers are connected to this receiver (without the rear speakers or center speaker).**

Dolby Surround (Dolby Digital and Dolby Pro Logic)*

Used to watch the soundtracks of software encoded with Dolby Digital (bearing the mark ) or with Dolby Surround (bearing the mark ) .

Dolby Surround encoding format records the left front channel, right front channel, center channel, and rear channel (total 4 channels) signals into 2 channels. The Dolby Pro Logic decoder built in this receiver decodes these 2 channel signals into original 4 channel signals — matrix-based multichannel reproduction, and allows you to enjoy the realistic stereo sounds in your listening room.

On the other hand, Dolby Digital encoding method (so called discrete 5.1 channel digital audio format) records and compresses the left front channel, right front channel, center channel, left rear channel, right rear channel, and LFE channel (total 6 channels, but LFE channel is counted as 0.1 channel, therefore called 5.1 channels) signals digitally. Each channel is completely independent from other channel signals to avoid interference, therefore, you can obtain much better sound quality with much stereo and surround effects.

The Dolby Digital decoder built in this receiver can create much more realistic sound field in your listening room. You may feel as if you were in a real theater.

In addition, Dolby Digital enables stereo rear sounds, and sets the cutoff frequency of the rear treble at 20 kHz, compared to 7 kHz for Dolby Pro Logic. These facts enhance the sound movement and being-there feelings much more than Dolby Pro Logic.

- To enjoy the software encoded with Dolby Digital, you must connect the source component using the digital terminal on the rear of this receiver. (See page 7.)

DTS Digital Surround**

DTS Digital Surround is another discrete 5.1 channel digital audio format available on CD, LD, and DVD software. Compared to Dolby Digital, audio compression rate is relatively low. This fact allows DTS Digital Surround format to add breadth and depth to the reproduced sounds. As a result, DTS Digital Surround features natural, solid and clear sound.

- To enjoy the software encoded with DTS Digital Surround, you must connect the source component using the digital terminal on the rear of this receiver. (See page 7.)

JVC Theater Surround

In order to reproduce a more realistic sound field in your listening room while playing soundtracks of software encoded with Dolby Surround (bearing the mark ) , you can use JVC Theater Surround.

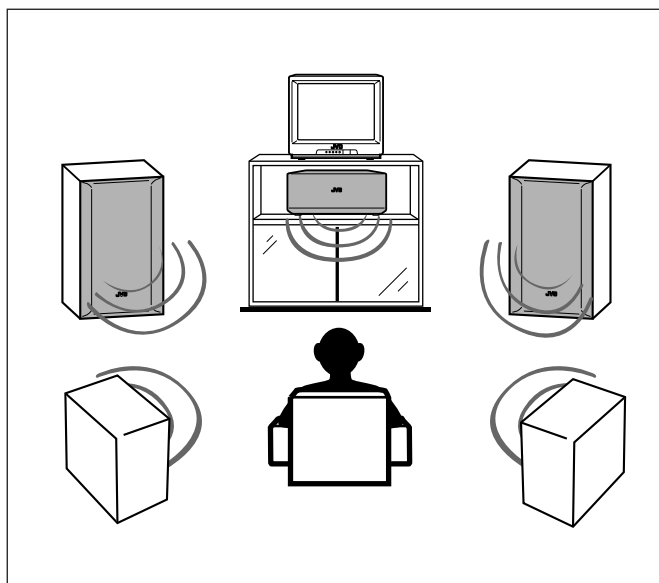

Notes:

- The DSP modes have no effect on monaural sources.
- The PRO LOGIC indicator lights up when the Dolby Pro Logic decoder built in this receiver is activated.

* Manufactured under license from Dolby Laboratories. "Dolby," "Pro Logic," and the double-D symbol are trademarks of Dolby Laboratories. Confidential Unpublished Works. ©1992–1997 Dolby Laboratories, Inc. All rights reserved.

** Manufactured under license from Digital Theater Systems, Inc. US Pat. No. 5,451,942 and other world-wide patents issues and pending. "DTS" and "DTS Digital Surround" are trademarks of Digital Theater Systems, Inc. ©1996 Digital Theater Systems, Inc. All rights reserved.

DAP modes

In order to reproduce a more acoustic sound field in your listening room while playing soundtracks of stereo sources, you can use DAP modes. **This mode can be used when the front speakers and the rear speakers are connected to this receiver (without respect to the center speaker connection).**

You can select one of the following to your preference.

LIVE CLUB: Gives the feeling of a live music club with a low ceiling.

DANCE CLUB: Gives a throbbing bass beat.

HALL: Gives clear vocal and the feeling of a concert hall.

PAVILION: Gives the spacious feeling of a pavilion with a high ceiling.

Reproducing the Sound Field

The sound heard in a concert hall or club consists of direct sound and indirect sound — early reflections and reflections from behind. Direct sounds reach the listener directly without any reflection. On the other hand, indirect sounds are delayed by the distances of the ceiling and walls. These direct sounds and indirect sounds are the most important elements of the acoustic surround effects. JVC Theater Surround and DAP modes can create these important elements, and give you a real “being there” feeling.

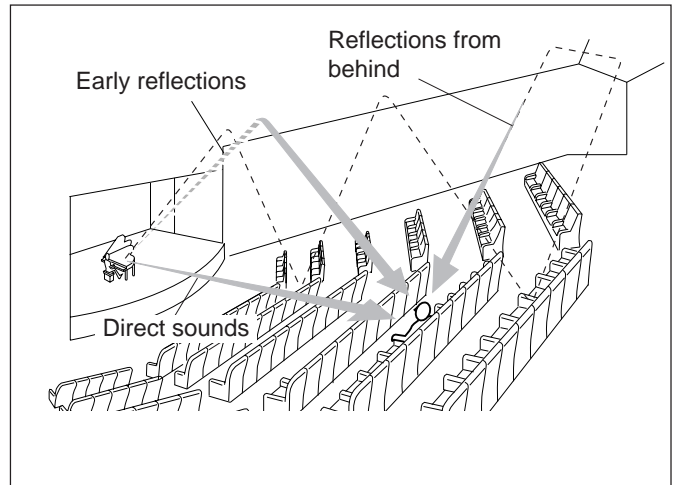

Available DSP modes according to the input mode

○: Possible ×: Impossible

* You can also use SURROUND on the remote control to activate the surround mode.

BUTTON (On the remote control)		SURROUND MODE						
BUTTON (On the front panel)		SURROUND ON/OFF*	DSP MODE					
MODE		SURROUND ON	THEATER	LIVE CLUB	DANCE CLUB	HALL	PAVILION	DSP OFF (SURROUND OFF)
INPUT	ANALOG (2 CH)	○ (DOLBY PRO LOGIC)	○	○	○	○	○	○
	LINEAR PCM	○ (DOLBY PRO LOGIC)	○	○	○	○	○	○
	DOLBY DIGITAL	○*1 (DOLBY DIGITAL)	×	×	×	×	×	○
	DTS	○*2 (DTS SURROUND)	×	×	×	×	×	○

*1 When 2 channel signal comes in, DOLBY PRO LOGIC is selected. When other signals come in, DOLBY DIGITAL is selected.

*2 When 2 channel signal comes in, DOLBY PRO LOGIC is selected. When other signals come in, DTS SURROUND is selected.

Available DSP Modes According to the Speaker Arrangement

Available DSP modes will vary depending on how many speakers are used with this receiver.

Make sure that you have set the speaker information correctly (see page 12).

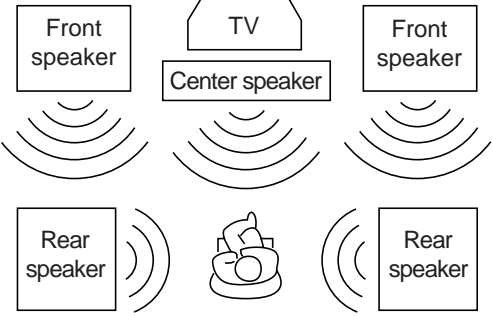
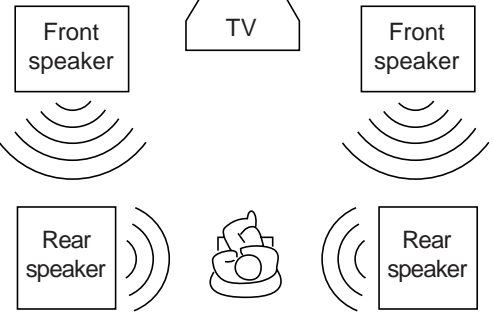
Speaker arrangements	Available DSP modes
	<p>Each time you press DSP MODE on the front panel or SURROUND MODE on the remote control, the DSP modes change as follows:</p> <p>By pressing DSP MODE:</p> <ul style="list-style-type: none"> • THEATER • LIVE CLUB • DANCE CLUB • HALL • PAVILION • DSP OFF (DSP mode is canceled) <p>By pressing SURROUND MODE:</p> <ul style="list-style-type: none"> • SURROUND ON (DOLBY PRO LOGIC, DOLBY DIGITAL, or DTS SURROUND) • THEATER • LIVE CLUB • DANCE CLUB • HALL • PAVILION • DSP OFF (DSP mode is canceled) <div style="display: flex; justify-content: space-between;"> <div data-bbox="683 840 1042 965" style="border: 1px solid black; padding: 5px;"> <p>To activate the Surround mode, press SURROUND ON/OFF on the front panel.</p> </div> <div data-bbox="1070 840 1434 965" style="border: 1px solid black; padding: 5px;"> <p>To activate the Surround mode, you can also press SURROUND on the remote control.</p> </div> </div>
	<p>Each time you press DSP MODE on the front panel or SURROUND MODE on the remote control, the DSP modes change as follows:</p> <p>By pressing DSP MODE:</p> <ul style="list-style-type: none"> • THEATER • DSP OFF (DSP mode is canceled) <p>By pressing SURROUND MODE:</p> <ul style="list-style-type: none"> • SURROUND ON (DOLBY PRO LOGIC, DOLBY DIGITAL, or DTS SURROUND) • DSP OFF (DSP mode is canceled) <div style="display: flex; justify-content: space-between;"> <div data-bbox="683 1523 1042 1648" style="border: 1px solid black; padding: 5px;"> <p>To activate the Surround mode, press SURROUND ON/OFF on the front panel.</p> </div> <div data-bbox="1070 1523 1434 1648" style="border: 1px solid black; padding: 5px;"> <p>To activate the Surround mode, you can also press SURROUND on the remote control.</p> </div> </div>

Adjusting the Surround Modes

Once you have adjusted the Surround modes, the adjustment is memorized for each Surround mode.



Dolby and DTS Surround adjustments

Before you start, remember...

- Make sure that you have set the speaker information correctly (see page 12).
- There is a time limit in doing the following steps. If the setting is canceled before you finish, start from step 3 again.
- You cannot adjust the rear speaker output levels when you have set "REAR SPK" to "NO." See page 12.
- You cannot adjust the center speaker output level when you have set "CENTER SPK" to "NO." See page 12.

From the remote control:

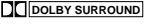
1. Select and play a sound source.

- To enjoy Dolby Pro Logic, play back a software encoded with Dolby Surround and labeled with  mark.
- To enjoy Dolby Digital, play back a software encoded with Dolby Digital and labeled with  mark.
- To enjoy DTS Digital Surround, play back a software encoded with DTS Digital Surround and labeled with  mark.

2. Press SURROUND to activate an appropriate Surround mode — PRO LOGIC, DOLBY DIGITAL or DTS SURROUND.



When "PRO LOGIC" is selected, the PRO LOGIC indicator lights up on the display.

- Each time you press the button, the Surround mode turns on and off alternately.

Note:

You can also press SURROUND MODE to activate an appropriate Surround mode — PRO LOGIC, DOLBY DIGITAL, or DTS SURROUND.

3. Press SOUND.

The 10 keys are activated for sound adjustments.

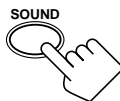

4. Press TEST to check the speaker output balance.

"TEST TONE L" starts flashing on the display, and a test tone comes out of the speakers in the following order:

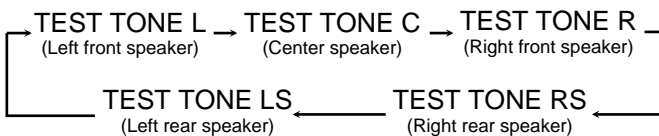
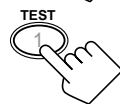

Notes:

- You can adjust the speaker output levels without outputting the test tone.
- No test tone comes out of the center speaker when "CENTER SPK" is set to "NO" (see page 12).
- No test tone comes out of the rear speakers when "REAR SPK" is set to "NO" (see page 12).

5. Adjust the speaker output levels.

- To adjust the center speaker level, press CENTER +/- (from +10 dB to -10 dB).
- To adjust the left rear speaker level, press REAR•L +/- (from +10 dB to -10 dB).
- To adjust the right rear speaker level, press REAR•R +/- (from +10 dB to -10 dB).

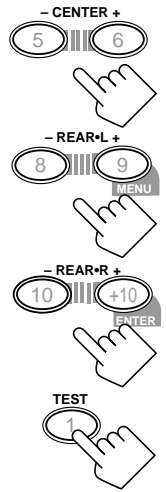



6. Press TEST again to stop the test tone.

On the front panel:

You can also use the buttons on the front panel to adjust the Surround modes. However, no test tone is available when using the buttons on the front panel. So, make adjustments while listening to the sound of the source played back.

1. Select and play a sound source.

- To enjoy Dolby Pro Logic, play back a software encoded with Dolby Surround and labeled with  mark.
- To enjoy Dolby Digital, play back a software encoded with Dolby Digital and labeled with  mark.
- To enjoy DTS Digital Surround, play back a software encoded with DTS Digital Surround and labeled with  mark.

2. Press SURROUND ON/OFF to activate an appropriate Surround mode — PRO LOGIC, DOLBY DIGITAL or DTS SURROUND.



When "PRO LOGIC" is selected, the PRO LOGIC indicator lights up on the display.

- Each time you press the button, the Surround mode turns on and off alternately.

3. Adjust the speaker output levels.

- 1) Press ADJUST repeatedly until one of the following indications appears on the display.

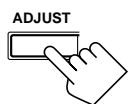

"CENTER LEVEL":

To adjust the center speaker level.

"REAR L LEVEL":

To adjust the left rear speaker level.

"REAR R LEVEL":

To adjust the right rear speaker level.

- 2) Press CONTROL UP ▲/DOWN ▼ to adjust the selected speaker output level (from +10 dB to -10 dB).

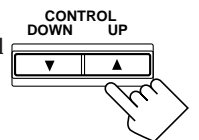

- 3) Repeat 1) and 2) to adjust the other speaker output levels.

JVC Theater Surround adjustments

Before you start, remember...

- Make sure that you have set the speaker information correctly (see page 12).
- There is a time limit in doing the following steps. If the setting is canceled before you finish, start from step 2 again.
- You cannot adjust the rear speaker output levels when you have set "REAR SPK" to "NO." See page 12.
- You cannot adjust the center speaker output level when you have set "CENTER SPK" to "NO." See page 12.

From the remote control:

1. Press **SURROUND MODE** repeatedly until "THEATER" appears on the display.

The PRO LOGIC and DSP indicators also light up on the display.



2. Press **SOUND**.

The 10 keys are activated for sound adjustments.

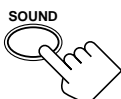

3. Press **TEST** to check the speaker output balance.

"TEST TONE L" starts flashing on the display, and a test tone comes out of the speakers in the following order:

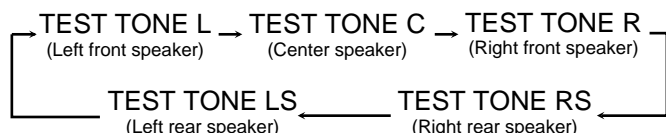
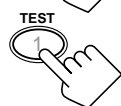

Notes:

- You can adjust the speaker output levels without outputting the test tone.
- No test tone comes out of the center speaker when "CENTER SPK" is set to "NO" (see page 12).
- No test tone comes out of the rear speakers when "REAR SPK" is set to "NO" (see page 12).

4. Adjust the speaker output levels.

- To adjust the center speaker level, press CENTER +/- (from +10 dB to -10 dB).
- To adjust the left rear speaker level, press REAR•L +/- (from +10 dB to -10 dB).
- To adjust the right rear speaker level, press REAR•R +/- (from +10 dB to -10 dB).

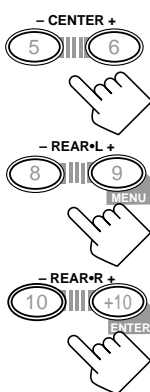

5. Press **TEST** again to stop the test tone.

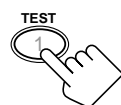

6. Press **EFFECT** to select an effect level you want.

- Each time you press the button, the effect level changes as follows:

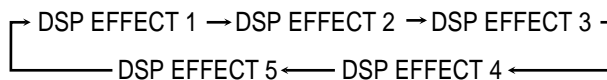

As the number increases, JVC Theater Surround becomes stronger (normally set it to "DSP EFFECT 3").

On the front panel:

You can also use the buttons on the front panel to adjust the Surround modes. However, no test tone is available when using the buttons on the front panel. So, make adjustments while listening to the sound of the source played back.

1. Press **DSP MODE** repeatedly until "THEATER" appears on the display.

The PRO LOGIC and DSP indicators also light up on the display.

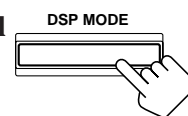

2. Adjust the speaker output levels.

- 1) Press **ADJUST** repeatedly until one of the following indications appears on the display.

"CENTER LEVEL":

To adjust the center speaker level.

"REAR L LEVEL":

To adjust the left rear speaker level.

"REAR R LEVEL":

To adjust the right rear speaker level.

- 2) Press **CONTROL UP ▲/DOWN ▼** to adjust the selected speaker output level (from +10 dB to -10 dB).
- 3) Repeat 1) and 2) to adjust the other speaker output levels.

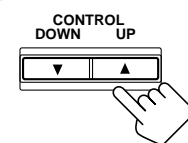
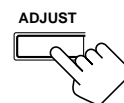

3. Adjust the effect level.

- 1) Press **ADJUST** repeatedly until "DSP EFFECT" appears on the display.

The display changes to show the current setting.

- 2) Press **CONTROL UP ▲/DOWN ▼** to select the effect level.

- Each time you press the button, the effect level changes as follows:

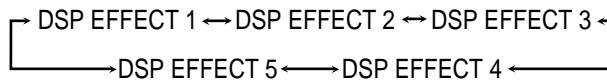
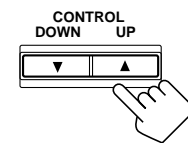
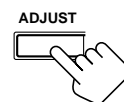

As the number increases, JVC Theater Surround becomes stronger (normally set it to "DSP EFFECT 3").

Adjusting the DAP Modes

Once you have adjusted the DAP modes, the adjustment is memorized for each DAP mode.

Before you start, remember...

- Make sure that you have set the speaker information correctly (see page 12).
- There is a time limit in doing the following steps. If the setting is canceled before you finish, start from step 1 again.
- You cannot adjust the rear speaker output level when you have set "REAR SPK" to "NO." See page 12.

On the front panel:

1. Press **DSP MODE** repeatedly until the DAP mode — **LIVE CLUB, DANCE CLUB, HALL, or PAVILION** — appears on the display.

The DSP indicator also lights up on the display.

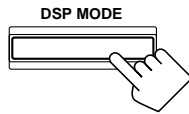

2. Adjust the rear speaker output levels.

- 1) Press **ADJUST** repeatedly until one of the following indications appears on the display.

"REAR L LEVEL":

To adjust the left rear speaker level.

"REAR R LEVEL":

To adjust the right rear speaker level.

- 2) Press **CONTROL UP ▲/DOWN ▼** to adjust the selected speaker output level (from +10 dB to -10 dB).
- 3) Repeat 1) and 2) to adjust the other speaker output level.

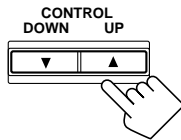
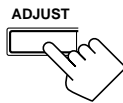

3. Adjust the effect level.

- 1) Press **ADJUST** repeatedly until "DSP EFFECT" appears on the display.

The display changes to show the current setting.

- 2) Press **CONTROL UP ▲/DOWN ▼** to select the effect level.

- Each time you press the button, the effect level changes as follows:

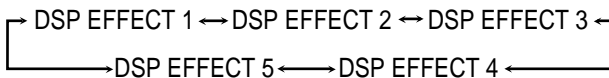
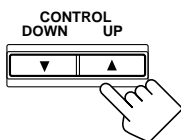
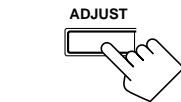

As the number increases, the selected DAP mode becomes stronger (normally set it to "DSP EFFECT 3").

From the remote control:

1. Press **SURROUND MODE** repeatedly until the DAP mode — **LIVE CLUB, DANCE CLUB, HALL, or PAVILION** — appears on the display.

The DSP indicator also lights up on the display.



2. Press **SOUND**.

The 10 keys are activated for sound adjustments.

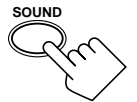

3. Adjust the rear speaker output levels.

- To adjust the left rear speaker level, press **REAR•L +/-** (from +10 dB to -10 dB).
- To adjust the right rear speaker level, press **REAR•R +/-** (from +10 dB to -10 dB).

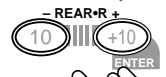
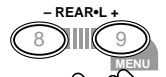

4. Press **EFFECT** to select an effect level you want.

- Each time you press the button, the effect level changes as follows:

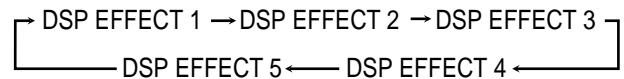
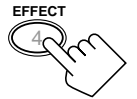

As the number increases, the selected DAP mode becomes stronger (normally set it to "DSP EFFECT 3").

Activating the DSP Modes

You can use only one DSP mode at a time. When a DSP mode is activated, another DSP mode is canceled if in use.

For Dolby Pro Logic, Dolby Digital, and DTS Digital Surround

On the front panel:

1. Press SURROUND ON/OFF.

- Each time you press the button, the Dolby/DTS Surround mode turns on and off alternately.

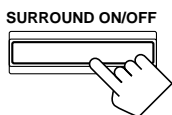

2. Select and play a sound source.

- To enjoy Dolby Pro Logic, play back a software encoded with Dolby Surround and labeled with mark.
- To enjoy Dolby Digital, play back a software encoded with Dolby Digital and labeled with mark.
- To enjoy DTS Digital Surround, play back a software encoded with DTS Digital Surround and labeled with mark.

To cancel the Dolby/DTS Surround mode

Press SURROUND ON/OFF again. (“SURROUND OFF” appears on the display.)

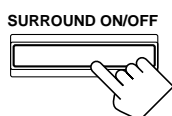

From the remote control:

1. Press SURROUND.

- Each time you press the button, the Dolby/DTS Surround mode turns on and off alternately.
- You can also turn on Dolby/DTS Surround mode by pressing SURROUND MODE.



2. Select and play a sound source.

- To enjoy Dolby Pro Logic, play back a software encoded with Dolby Surround and labeled with mark.
- To enjoy Dolby Digital, play back a software encoded with Dolby Digital and labeled with mark.
- To enjoy DTS Digital surround, play back a software encoded with DTS Digital Surround and labeled with mark.

To cancel the Dolby/DTS Surround mode

Press SURROUND again. (“SURROUND OFF” appears on the display.)



For the other DSP modes

On the front panel:

1. Press DSP MODE repeatedly until the mode you want appears on the display.

- Each time you press the button, the DSP modes change. (See page 20 for more details.)

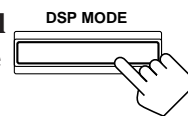

2. Select and play a sound source.

- To enjoy JVC Theater Surround, play back a software encoded with Dolby Surround and labeled with mark.

To cancel the DSP mode

Press DSP MODE repeatedly until “DSP OFF” appears on the display.

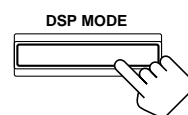

From the remote control:

1. Press SURROUND MODE repeatedly until the DSP mode you want appears on the display.

- Each time you press the button, the DSP modes change.



2. Select and play a sound source.

- To enjoy JVC Theater Surround, play back a software encoded with Dolby Surround and labeled with mark.

To cancel the DSP mode

Press SURROUND MODE repeatedly until “DSP OFF” appears on the display.

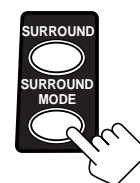

COMPU LINK Remote Control System

The COMPU LINK remote control system allows you to operate JVC audio components through the remote sensor on the receiver.

To use this remote control system, you need to connect JVC audio components through the COMPU LINK (SYNCHRO) jacks (see below) in addition to the connections using cables with RCA pin plugs (see page 5).

- Make sure that the AC power cords of these components are unplugged before connection. Plug the AC power cords only after all connections are complete.

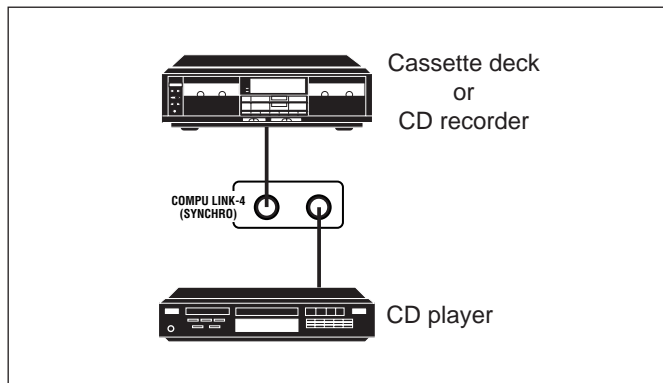

Notes:

- There are four versions of COMPU LINK remote control system. This receiver is equipped with the fourth version — COMPU LINK-4. This version is added systematic operations with the CD recorder to the previous version — COMPU LINK-3.
- If your audio component has two COMPU LINK jacks, you can use either one. If it has only one COMPU LINK jack, connect it so that it is the last item in the series of components. (For example, the CD player in the diagram above.)
- To operate the cassette deck or CD recorder using the COMPU LINK remote control system, set the source name correctly. (See page 11.)
- Refer also to the manuals supplied with your audio components.

This remote control system allows you to use four functions listed below.

Remote Control through the Remote Sensor on the Receiver

You can control the connected audio components through the remote sensor on the receiver using this remote control. Aim the remote control directly at the remote sensor on the receiver. For details, see pages 26 and 27.

Automatic Source Selection

When you press the play (▶) button on a connected component or on its own remote control, the receiver automatically turns on and changes the source to the component. On the other hand, if you select a new source on the receiver or on the remote control, the selected component begins playing immediately.

In both cases, the previously selected source continues playing without sound for a few seconds.

Automatic Power On/Off (Standby): only possible with the COMPU LINK-3 and COMPU LINK-4 connection

Both the CD player and cassette deck (or CD recorder) turn on and off (standby) along with the receiver.

When you turn on the receiver, the CD player or cassette deck (or CD recorder) will turn on automatically, depending on which component has been previously selected.

When you turn off the receiver, both the CD player and cassette deck (or CD recorder) will turn off (standby).

Synchronized Recording

Synchronized recording means the cassette deck starts recording as soon as a CD or a record begins playing.

To use synchronized recording, follow these steps:

1. Put a tape in the cassette deck and a disc in the CD player.
2. Press the record (●) button and the pause (II) button on the cassette deck at the same time.

This puts the cassette deck into recording pause.

If you do not press the record (●) button and pause (II) button at the same time, the synchronized recording feature will not operate.

3. Press the play (▶) button on the CD player.

The source changes on the receiver, and as soon as play starts, the cassette deck starts recording. When the play ends, the cassette deck enters recording pause, and stops about 4 seconds later.

Notes:

- During synchronized recording, the selected source cannot be changed.
- If the power of any component is shut off during synchronized recording, the COMPU LINK remote control system may not operate properly. In this case, you must start again from the beginning.

Operating JVC's Audio/Video Components

You can operate JVC's audio and video components with this receiver's remote control, since control signals for JVC components are preset in the remote control.

Operating Audio Components

IMPORTANT:

To operate JVC's audio components using this remote control:

- You need to connect JVC audio components through the COMPU LINK (SYNCHRO) jacks (see page 25) in addition to the connections using cables with RCA pin plugs (see page 5).
- Aim the remote control directly at the remote sensor on the receiver.
- If you use the buttons on the front panel, the remote control will not operate that source. To operate a source with the remote control, the source must be selected using source selecting buttons on the remote control.
- To operate the cassette deck or CD recorder using the COMPU LINK remote control system, set the source name correctly. (See page 11.)
- Refer also to the manuals supplied with your components.

Tuner

After pressing FM/AM, you can perform the following operations:

- FM/AM: Alternates between FM and AM.
1 – 10, +10: Selects a preset channel number directly.
For channel number 5, press 5.
For channel number 15, press +10, then 5.
For channel number 20, press +10, then 10.

Sound control section (Amplifier)

You can always perform the following operations:

- SURROUND: Turns on or off the Surround modes — Dolby Pro Logic, Dolby Digital, and DTS Digital Surround.
SURROUND MODE: Selects the DSP modes.

After pressing SOUND, you can perform the following operations:

- SUBWOOFER +/-: Adjusts the subwoofer output level.
CENTER +/-: Adjusts the center speaker output level.
REAR•L +/-: Adjusts the left rear speaker output level.
REAR•R +/-: Adjusts the right rear speaker output level.
EFFECT: Selects the effect level.
TEST: Turns on or off the test tone output.

Note:

After adjusting sounds, press the corresponding source selecting button or CD-DISC to operate your target source by using the 10 keys; otherwise, the 10 keys cannot be used for operating your target source.

CD player

After pressing CD, you can perform the following operations on the CD player:

- ▶: Starts playing.
◀◀: Returns to the beginning of the current (or previous) track.
▶▶: Skips to the beginning of the next track.
■: Stops playing.
||: Pauses playing. To release it, press ▶.
1 – 10, +10: Selects a track number directly.
For track number 5, press 5.
For track number 15, press +10, then 5.
For track number 20, press +10, then 10.
For track number 30, press +10, +10, then 10.

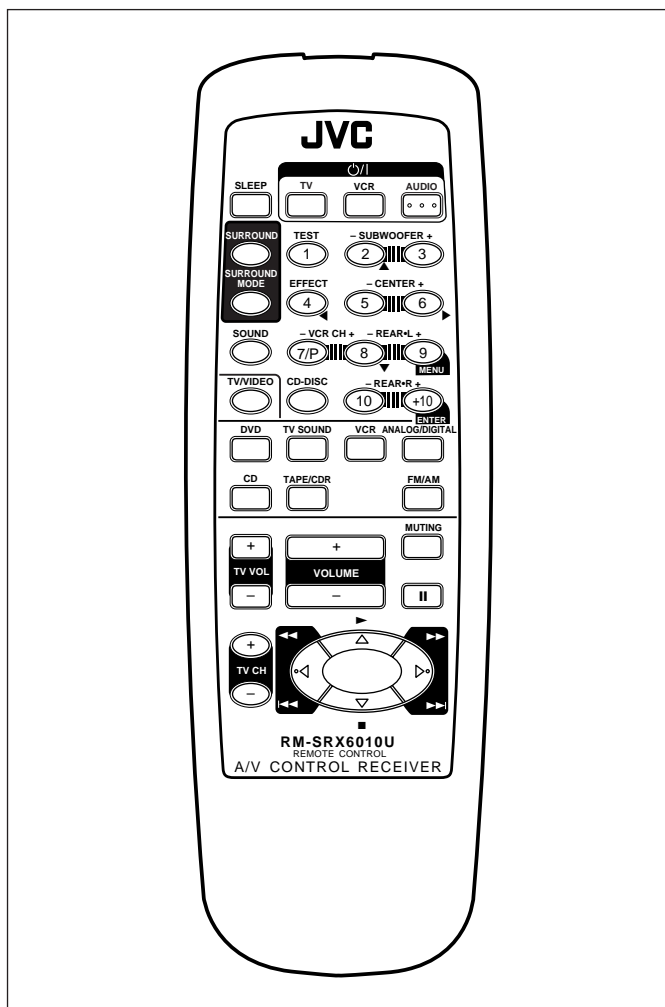

CD changer

After pressing CD-DISC, you can perform the following operations on a CD changer:

- ▶: Starts playing.
- ◀◀: Returns to the beginning of the current (or previous) track.
- ▶▶: Skips to the beginning of the next track.
- : Stops playing.
- ||: Pauses playing. To release it, press ▶.
- 1 – 6, 7/P: Selects the number of a disc installed in a CD changer.

Cassette deck

After pressing TAPE/CDR, you can perform the following operations on a cassette deck:

- ▶: Starts playing.
- ◀◀: Fast winds the tape from right to left.
- ▶▶: Fast winds the tape from left to right.
- : Stops operations.
- ||: Pauses playing. To release it, press ▶.

Note:

Before starting the above operations, make sure that you have changed the source name correctly. See page 11.

CD recorder

After pressing TAPE/CDR, you can perform the following operations on the CD recorder:

- ▶: Starts playing.
- ◀◀: Returns to the beginning of the current (or previous) track.
- ▶▶: Skips to the beginning of the next track.
- : Stops playing.
- ||: Pauses playing. To release it, press ▶.

Note:

Before starting the above operations, make sure that you have changed the source name correctly. See page 11.

Operating Video Components**IMPORTANT:**

To operate JVC's video components using this remote control:

- Some JVC VCRs can accept two types of the control signals — remote code "A" and "B." Before using this remote control, make sure that the remote control code of the VCR connected to the VCR jacks is set to code "A."
- When using the remote control:
 - For the DVD player, TV and VCR operations, aim the remote control directly at the remote sensor on each component, not on the receiver.

VCR

You can always perform the following operations:

VCR: Turns on or off the VCR.
(in the \odot/I (standby/on) section)

After pressing VCR, you can perform the following operations on the VCR:

- ▶: Starts playing.
- ◀◀: Rewinds a tape.
- ▶▶: Fast winds a tape.
- : Stops operations.
- ||: Pauses playing. To release it, press ▶.
- VCR CH +/-: Changes the TV channels on the VCR.

DVD player

After pressing DVD, you can perform the following operations on a DVD player:

- ▶: Starts playing.
- ◀◀: Returns to the beginning of the current (or previous) track.
- ▶▶: Skips to the beginning of the next track.
- : Stops playing.
- ||: Stops playing temporarily. To release it, press ▶.

After pressing DVD, these buttons can be used for the DVD menu operations.

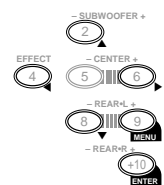
**Note:**

For detailed menu operations, refer to the instructions supplied with the discs or the DVD player.





TV

You can always perform the following operations:

- TV: Turns on or off the TV.
(in the \odot/I (standby/on) section)
- TV/VIDEO: Sets the input mode (either TV or VIDEO).
- TV VOL +/-: Adjusts the volume.
- TV CH +/-: Changes the channels.

Troubleshooting

Use this chart to help you solve daily operational problems. If there is any problem you cannot solve, contact your JVC service center.

PROBLEM	POSSIBLE CAUSE	SOLUTION
The display does not light up.	The power cord is not plugged in.	Plug the power cord into an AC outlet.
No sound from speakers.	Speaker signal cables are not connected.	Check speaker wiring and reconnect if necessary.
	The SPEAKERS ON/OFF button is not set correctly.	Press SPEAKERS ON/OFF button correctly.
	An incorrect source is selected.	Select the correct source.
	Muting is activated.	Press MUTING to cancel the mute.
	An incorrect input mode (analog or digital) is selected.	Select the correct input mode (analog or digital).
Sound from one speaker only.	Connections are incorrect.	Check connections. For analog connections, see page 5. For digital connections, see page 7.
	Speaker signal cables are not connected properly.	Check speaker wiring and reconnect if necessary.
Continuous hiss or buzzing during FM reception.	The balance is set to one extreme.	Adjust the balance properly (see page 11).
	Incoming signal is too weak.	Connect an outdoor FM antenna or contact your dealer.
	The station is too far away.	Select a new station.
	An incorrect antenna is used.	Check with your dealer to be sure you have the correct antenna.
Occasional cracking noise during FM reception.	Antennas are not connected properly.	Check connections.
"OVERLOAD" starts flashing on the display.	Ignition noise from automobiles.	Move the antenna farther from automobile traffic.
	Speakers are overloaded because of high volume.	1. Press STANDBY/ON  on the front panel to turn off the receiver. 2. Stop the playback source. 3. Turn on the receiver again, and adjust the volume.
"DSP MICON NG" starts flashing on the display.	Speakers are overloaded because of short circuit of speaker terminals.	Press STANDBY/ON  on the front panel, then check the speaker wiring. If "OVERLOAD" does not disappear, unplug the AC power cord, then plug it back again. If speaker wiring is not short-circuited, contact your dealer.
	The built-in microcomputer is not functioning correctly.	Press STANDBY/ON  on the front panel to turn off the receiver. After unplugging the power cord, consult your dealer.
The STANDBY lamp lights up after turning on the power, but soon the receiver turns off (into standby mode).	The receiver is overloaded because of a high voltage.	Press STANDBY/ON  on the front panel to turn off the receiver. After unplugging the power cord, consult your dealer.
Remote control does not work.	There is an obstruction in front of the remote sensor on the receiver.	Remove the obstruction.
	Batteries are weak.	Replace batteries.
Remote control does not operate intendedly.	An incorrect remote control operation mode is selected.	Select the correct remote control operation mode. (See page 26).

Specifications

Amplifier

Output Power

At Stereo operation:

Front channels: 100 W* per channel, min. RMS, both channels driven into 8 Ω at 1 kHz with no more than 0.9% total harmonic distortion. (IEC268-3/DIN)

At Surround operation:

Front channels: 100 W* per channel, min. RMS, driven into 8 Ω at 1 kHz with no more than 0.8% total harmonic distortion.

Center channel: 100 W*, min. RMS, driven into 8 Ω at 1 kHz, with no more than 0.8% total harmonic distortion.

Rear channels: 100 W* per channel, min. RMS, driven into 8 Ω at 1 kHz, with no more than 0.8% total harmonic distortion.

(* Measured on AC 110 V, 127 V, 220 V and 240 V)

Audio

Audio Input Sensitivity/Impedance (1 kHz): CD, TAPE/CDR, TV SOUND, VCR, DVD: 220 mV/47 k Ω

Audio Input (DIGITAL IN)* : Coaxial: DIGITAL 1 (DVD): 0.5 V (p-p)/75 Ω
Optical: DIGITAL 2 (CD): -21 dBm to -15 dBm (660 nm ±30 nm)

* Corresponding to Linear PCM, Dolby Digital, and DTS Digital Surround (with sampling frequency — 32 kHz, 44.1 kHz, 48 kHz).

Audio Output Level: TAPE/CDR, VCR: 220 mV

Signal-to-Noise Ratio ('66 IHF/DIN): CD, TAPE/CDR, TV SOUND, VCR, DVD: 87 dB/67 dB

Frequency Response (8 Ω): CD, TAPE/CDR, TV SOUND, VCR, DVD: 20 Hz to 20 kHz (±1 dB)

Tone Control: Bass (100 Hz): ±10 dB
Treble (10 kHz): ±10 dB

Video

Video Input Sensitivity/Impedance:
Composite video: VCR, DVD: 1 V (p-p)/75 Ω

Video Output Level:
Composite video: VCR, MONITOR OUT: 1 V (p-p)/75 Ω

Synchronization: Negative

Signal-to-Noise Ratio: 45 dB

FM tuner (IHF)

Tuning Range:	87.50 MHz to 108.00 MHz	
Usable Sensitivity:	Monaural:	12.8 dBf (1.95 μ V/75 Ω)
50 dB Quieting Sensitivity:	Monaural:	21.3 dBf (3.2 μ V/75 Ω)
	Stereo:	41.3 dBf (31.5 μ V/75 Ω)
Signal-to-Noise Ratio (IHF-A weighted):	Monaural:	78 dB at 85 dBf
	Stereo:	73 dB at 85 dBf
Total Harmonic Distortion:	Monaural:	0.4% at 1 kHz
	Stereo:	0.6% at 1 kHz
Stereo Separation at REC OUT:	35 dB at 1 kHz	
Alternate Channel Selectivity:	45 dB: (\pm 400 kHz)	
Frequency Response:	30 Hz to 15 kHz: (+0.5 dB, -3 dB)	

AM tuner

Tuning Range:	531 kHz to 1 602 kHz (at 9 kHz intervals) 530 kHz to 1 600 kHz (at 10 kHz intervals)	
Usable Sensitivity:	Loop antenna	400 μ V/m
Signal-to-Noise Ratio:	50 dB (100 mV/m)	

General

Power Requirements:	AC 110 V/127 V/220 V/230 V – 240 V [^] , adjustable with the voltage selector, 50 Hz/60 Hz	
Power Consumption:	200 W (at operation) 5 W (in standby mode)	
Dimensions (W x H x D):	435 mm x 146.5 mm x 416 mm (17 ³ / ₁₆ in. x 5 ¹³ / ₁₆ in. x 16 ⁷ / ₁₆ in.)	
Mass:	9.6 kg (21.2 lbs)	

Designs & specifications are subject to change without notice.

Mains (AC) Line Instruction (not applicable for Europe, U.S.A., Canada, Australia and U.K.)

Instrucción sobre la línea de la red (CA) (no aplicable para Europa, EE.UU., Canadá, Australia, ni el Reino Unido)

Instrução sobre a tensão da rede eléctrica (CA) (não aplicável para a Europa, os E.U.A., o Canadá, a Austrália e o Reino Unido)

主 (AC) 电源线路说明 (不适用于欧洲、美国、加拿大、澳洲及英国型号)

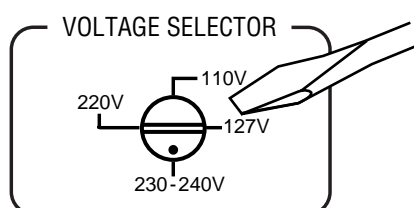
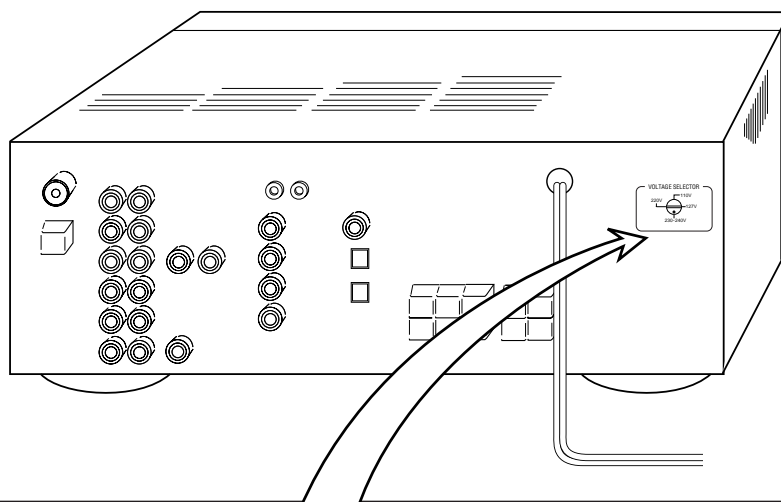

CAUTION for mains (AC) line

BEFORE PLUGGING IN, do check that your mains (AC) line voltage corresponds with the position of the voltage selector switch provided on the outside of this equipment and, if different, reset the voltage selector switch, to prevent from a damage or risk of fire/electric shock.

PRECAUCIÓN para la línea de la red (CA)

ANTES DE ENCHUFAR EL EQUIPO, compruebe si la tensión de la línea de la red (CA) corresponde con la posición del selector de tensión situado en la parte exterior del equipo, y si es diferente, reajuste el selector de tensión para evitar el riesgo de incendios/ descargas eléctricas.

PRECAUÇÃO para a ligação à tensão da rede (CA)

ANTES DE LIGAR O APARELHO A UMA TOMADA DA REDE, verifique se a tensão da rede CA corresponde à posição do selector de voltagem localizado na parte externa deste equipamento. Caso não corresponda, reajuste o selector de voltagem a fim de evitar avarias ou riscos de incêndio e choque eléctrico.

有关主(AC)电源线路的注意事项

接插电源以前, 务请检查当地的主 (AC) 电源线路电压是否和位于本机外面的电压选择开关设定的位置一致。如果不一致, 即重新设定电压选择开关使符合当地电压, 以免损坏机器或引起火灾/触电的危险。

JVC
VICTOR COMPANY OF JAPAN, LIMITED